

INFRARED GAS ANALYZER

DATA SHEET

ZRE

This gas analyzer (ZRE) is capable of measuring the concentration of NO, SO₂, CO₂, CO, CH₄ and O₂ components in sample gas. NO, SO₂, CO₂, CO and CH₄ are measured by non-dispersion infrared method (NDIR), while O₂ is measured by fuel cell, or zirconia method. Up to 5 components including O₂ can be measured simultaneously. This analyzer is designed with smaller physical dimensions. It is well suited for compact analyzing system designs.

In addition maintenance is simplified through adoption of the single-beam system.

Optimum use as an analyzer unit of measurement system for combustion exhaust gas from refuse incinerator and boiler, or gas from various industrial furnaces.



FEATURES

1. Small and light

The size is small 133×483×418mm (H×W×D) and light (8kg).

But it is capable max. 5 component measurement in one analyzer.

2. Easy maintenance

Because of single-beam system the measurement unit is simple with no need for optical adjustment. Therefore, maintenance is easy.

3. Easy operation

Operation can be carried out smoothly in an interactive way through a large-size LCD.

4. Abundant functions

Various optional functions are available such as auto calibration control, high and low concentration alarm, remote range switch, and range identification signal, etc.

SPECIFICATIONS

Standard Specifications

Principle of measurement:

NO, SO₂, CO₂, CO, CH₄ ;

Non-dispersion infrared-ray absorption method

Single light source and single beams (single beam system)

O₂ ; Fuel cell O₂ sensor (built in) or zirconia O₂ sensor (externally installed TYPE: ZFK7) (Built in paramagnetic O₂ sensor will be next revision.)

Measurable gas components and measuring range:

| | Minimum range | Maximum range |
|---|---------------|---------------|
| NO | 0 - 200ppm | 0 - 5000ppm |
| SO ₂ | 0 - 200ppm | 0 - 10vol% |
| CO ₂ | 0 - 100ppm | 0 - 100vol% |
| CO | 0 - 200ppm | 0 - 100vol% |
| CH ₄ | 0 - 500ppm | 0 - 100vol% |
| O ₂ (built in fuel cell) | 0 - 10vol% | 0 - 25vol% |
| O ₂ (built-in Paramagnetic / External Zirconia) | 0 - 5vol% | 0 - 25vol% |

- Max. 5 components measurement including O₂.
- Measuring range ratio max. 1:10
- Measuring ranges are changeable between the specified minimum and maximum range
Settable one range or two ranges
- For possible combinations of components and ranges, refer to Table1.

Measured value indication:

Digital indication in 4 digits (LCD with back light)

- Instantaneous value of each component
- Instantaneous value after O₂ correction (only in NO, SO₂, CO measurement with O₂)
- Average value after O₂ correction (only in NO, SO₂, CO measurement with O₂)
- O₂ average value

Analog output signals:

4 to 20mA DC or 0 to 1V DC, isolated internally from circuit and ground; 12 outputs max.

max. load 550Ω for 4 to 20 mA DC
min. load 100kΩ for 0 to 1V DC

* Refer to Table2 for the channel No. of displayed values and analog output signals.

Analog input signal:

For signal input from externally installed O₂ sensor.

Signal requirement;

(1) Signal from Fuji's Zirconia O₂ sensor (TYPE: ZFK7)

(2) 0 to 1V DC from an O₂ sensor
Input section is not isolated. This feature is effective when an O₂ sensor is not built in.

* Externally installed O₂ sensor should be purchased separately.

Digital output: (Option)

1c contact (24V DC/1A, resistive load) max.15 outputs

Instrument error, calibration error, range identification, auto calibration status, High/Low limit alarm contact output

* All relay contacts are isolated mutually and from the internal circuit.

Digital input: (Option)

Voltage contact (Supply 12 to 24V DC/15mA max. at ON) max. 9 inputs

Remote range switch, auto calibration remote start, remote holding, average value resetting, Isolated from the internal circuit with photocoupler.

Power supply: Voltage rating ; 100V to 240V AC
Allowable range ; 85V to 264V AC
Frequency ; 50Hz/60Hz
Power consumption ; 100VA max.

Operation conditions:

Ambient temperature;
-5°C to 45°C
(40°C max. when 2 optical system at 200V AC power source)

Ambient humidity ; 90% RH max., non-condensing

Storage conditions:

Ambient temperature; -20°C to 60°C
Ambient humidity ; 100% RH max., non-condensing

Dimensions (H × W × D):

19-inch rack mounting type:
133 x 483 x 418mm

Panel mounting type:
133 x 443 x 418mm

Mass: Approx. 8 kg

Finish color: Front panel; Black (DIC P 1000-F)
Cool gray (PANTON IC-F)

Casing; Cool gray (PANTON IC-F)

Enclosure: Steel casing, for indoor use

Material of gas-contacting parts:

Gas inlet/outlet; SUS304
Sample cell; SUS304, chloroprene rubber
Infrared-ray transmitting window; CaF₂
Paramagnetic O₂ sensor cell : SUS316
Fuel cell O₂ sensor cell : ABS resin
Internal piping; Toaron, Teflon

Gas inlet/outlet: Rc1/4 or NPT1/4 internal thread

Purge gas flow rate: 1L/min (when required)

Life time of fuel cell O₂ sensor:

2 years

Standard Functions**Output signal holding:**

Output signals are held during manual and auto calibrations by activation of holding (turning "ON" its setting).

The output to be held are the ones just before start calibration mode or setting value.

It is selectable.

Indication of instantaneous values will not be held.

Switch ranges: The switch ranges function is available in manual, auto, and remote modes. Only preset switch method is effective.

Manual: Allows range to switch by key operation.

Auto: Allows range to switch from low to high range when 90%FS or more is available in the low range.

Allows range to switch from high to low range when 80%FS or less is available in the low range.

Remote: Voltage contact input (for measurable components)

(Option) Allows range to switch via an external signal when remote range switch input is received.

When the contact input terminals for each component are input voltage, the first range is selected, and it is switched to the second range when the terminals are open.

* These range value are settable between original first range and second range.

Optional Functions**Remote output holding:**

Output signal is held at the latest value or setting value by voltage input the remote output holding input terminals.

Holding is maintained while the voltage input the terminals. Indication of instantaneous values will not be held.

Range identification signal:

The present measuring range is identified by a contact signal.

The contact output terminals for each component turn on when the first range is selected, and when the second range is selected, the terminals are open.

Auto calibration:

Auto calibration is carried out periodically at the preset cycle.

When a standard gas cylinder for calibration and a solenoid valve for opening/closing the gas flow line are prepared externally by the customer, calibration will be carried out with the solenoid valve drive contacts for zero calibration and each span calibration turned on/off sequentially at the set auto calibration timing.

Auto calibration cycle setting:

Auto calibration cycle is set.

Setting is variable within 1 to 99 hours (in increments of 1 hour) or 1 to 40 days (in increments of 1 day).

Gas flow time setting:

The time for flowing each calibration gas in auto calibration is set.
Settable within 60 to 900 seconds (in increments of 1 second)

Auto calibration remote start:

Auto calibration is carried out only once according to an external input signal. Calibration sequence is settable in the same way as the general auto calibration.
Auto calibration is started by opening the auto calibration remote start input terminals after input voltage for 1.5 seconds or longer.

Auto zero calibration:

Auto zero calibration is carried out periodically at the preset cycle.
This cycle is independent on "Auto calibration" cycle.
When zero calibration gas and solenoid valve for opening/closing the calibration gas flow line are prepared externally by the customer, zero calibration will be carried out with the solenoid valve drive contact for zero calibration turned on/off at the set auto zero calibration timing.

Auto zero calibration cycle setting:

Auto zero calibration cycle is set.
Setting is variable within 1 to 99 hours (in increments of 1 hour) or Setting is variable within 1 to 40 days (in increments of 1 day)

Gas flow time setting:

The timing for flowing zero gas in auto zero calibration is set.
Settable 60 to 900 seconds (in increments of 1 second)

High/low limit alarm:

Alarm contact output turns on when measurement value reach the preset high or low limit alarm value.
Contacts turn on when the channel value of each channel exceeds the high alarm limit value or falls below the low alarm limit value.

Instrument error contact output:

Contacts turn on at occurrence of analyzer error No. 1, 2, 3 or 10.

Calibration error contact output:

Contacts turn on at occurrence of manual or auto calibration error (any of errors No. 4 to 9).

Auto calibration status contact outputs:

Contacts turn on during auto calibration.

O₂ correction: Correction of measured NO, SO₂ and CO gas concentrations into values at reference O₂ concentration

Correction formula:

$$C = \frac{21-O_n}{21-O_s} \times C_s$$

C : Sample gas concentration after O₂ correction

C_s : Measured concentration of sample gas

O_s : Measured O₂ concentration (Limit setting: 1 to 20% O₂)

O_v : Reference O₂ concentration (value changeable by setting.0 to 19% O₂)

Average value after O₂ correction and O₂ average value calculation:

The result of O₂ correction or instantaneous O₂ value can be outputted as an average value in the preset period of time.
Used for averaging is the moving average method in which sampling is carried out at intervals of 30 seconds.
(Output is updated every 30 seconds. It is the average value in the determined period of time just before the latest updating.)
Averaging time is settable within 1 to 59 minutes (in increments of 1 minute) or 1 to 4 hours (in increments of 1 hour).

Average value resetting:

The above-mentioned output of average value is started from the initial state by opening the average value resetting input terminals after input voltage for 1.5 seconds or longer.
Output is reset by input voltage and restarted by opening

Communication function:

RS-485 (9pins D-sub) or USB (Type-B)
Half-duplex bit serial
Start-stop synchronization
ModbusTM protocol
Contents : Read/Write parameters
Read measurement concentration and instrument status
Remark : When connecting via RS-232C interface, an RS-232C ↔ RS-485 converter should be used.

Performance

Repeatability: ±0.5% of full scale
Linearity: ±1% of full scale
Zero drift: ±2% of full scale/week
In the case of auto zero calibration use for 500 ppm or less range
Span drift: ±2% of full scale/week
Response time (for 90% FS response) :
1 to 15 sec electrical response
Within 60 seconds including replacement time of sampling gas (when gas flow rate is 0.5L/min)
Gas replacement time depends on the number of measuring components, and measuring range.

Interference from other gases:

| Interference component | CO ₂ analyzer | CO analyzer | CH ₄ analyzer | SO ₂ analyzer | NO analyzer |
|-------------------------------------|--------------------------|--|--------------------------|--------------------------|-------------|
| CO 1000ppm | ≤1%FS | — | ≤1%FS | ≤1%FS | ≤1%FS |
| CO ₂ 15% | — | ≤1%FS (for 200ppm analyzer, ≤2.5%FS) | ≤1%FS | ≤1%FS | ≤1%FS |
| H ₂ O saturation at 20°C | ≤1%FS | ≤1%FS (for 500ppm analyzer, ≤2.5%FS) | ≤1%FS | — | — |
| H ₂ O saturation at 2°C | — | ≤2.5%FS (for 200ppm analyzer) | — | ≤2%FS | ≤2%FS |
| CH ₄ 1000ppm | ≤1%FS | ≤1%FS | — | ≤50ppm | — |

EC Directive Compliance

The product conforms to the requirements of the Low Voltage Directive 2006/95/EC and EMC directive 89/336/EEC (as amended by Directive 92/31/EEC), both as amended by Directive 93/68/EEC.

It conforms to following standards for product safety and electromagnetic compatibility ;

EN61010-1 : 2001 Safety requirements for electrical equipment for measurement, control and laboratory use.

“Installation Category II”
“Pollution Degree 2”

EN61326-1 : 1997, A1: 1998, A2: 2001, A3: 2003

Electrical equipment for measurement, control and laboratory use — EMC requirements.

CE

Standard Requirements for Sample Gas

Flow rate: 0.5L / min ±0.2L / min
Temperature: 0 to 50°C
Pressure: 10 kPa or less (Gas outlet side should be open to the atmospheric air.)
Dust: 100 µg/Nm³ or less in particle size of 0.3 µm or less
Mist: Unallowable
Moisture: Below a level where saturation occurs at room temperature (condensation unallowable).
 Below the level where saturation occurs at 2°C for CO measurement in 0 to 200 ppm range, NO measurement, and SO₂ measurement.

Corrosive component: 1 ppm or less

Standard gas for calibration:
 Zero gas ; Dry N₂
 Span gas ; Each sample gas having concentration 90 to 100% of its measuring range (recommended).

In case a zirconia O₂ analyzer is installed externally and calibration is carried out on the same calibration gas line:

Zero gas ; Dry air or atmospheric air
 Span gas ; For other than O₂ measurement, each sample gas having concentration 90 to 100% of its measuring range
 For O₂ measurement, O₂ gas of 1 to 2 vol%/remains N₂ gas

Installation Requirements

- Indoor use (Select a place where the equipment does not receive direct sunlight, draft/rain or radiation from hot substances. If such a place cannot be found, a roof or cover should be prepared for protection.)
- Avoid a place where unit receives heavy vibration
- Select a place where atmospheric air is clean

Principle diagram of NDIR type measurement (For CO₂, CO, CH₄, SO₂, NO)

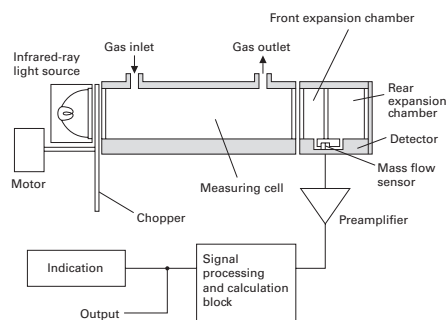

Principle diagram of fuel cell type measurement (For O₂)

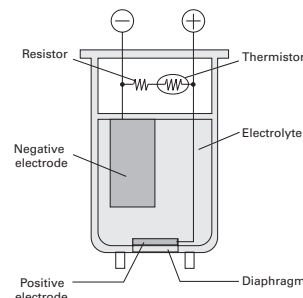

Principle diagram of paramagnetic type measurement (For O₂)

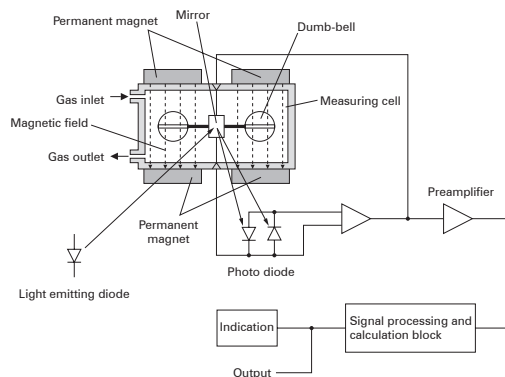

Examples of sampling system configuration including gas analyzer

To measure low moisture content (saturated at room temperature or lower) sample gas (CO, CO₂, CH₄)

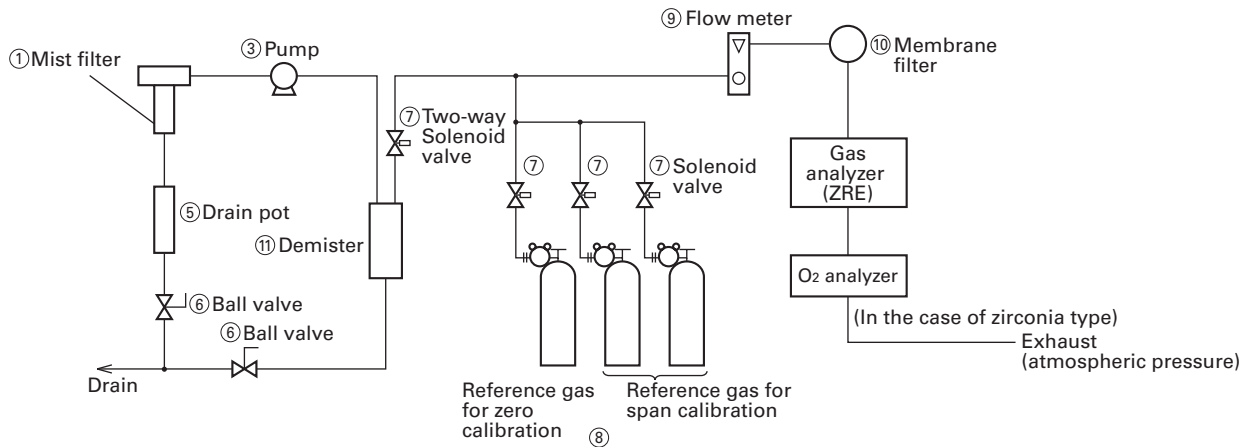

To measure high moisture content sample gas, NO, SO₂, or CO (0 to 200 ppm range)

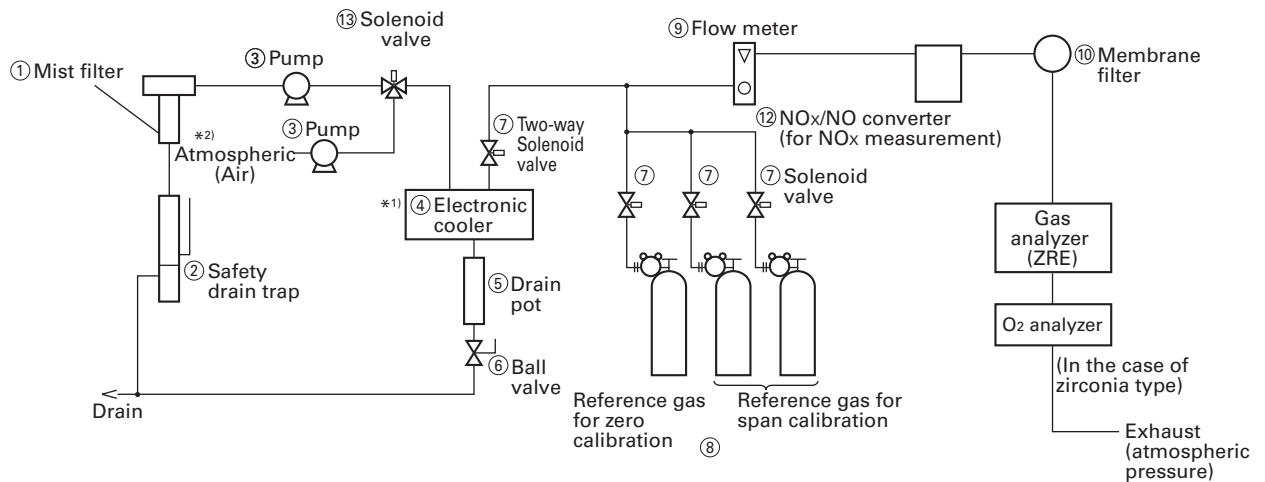

*1) Be sure to use a dehumidifier such as electronic cooler for NO, SO₂, and CO analyzers of 0 to 200 ppm range ($\approx 2^\circ\text{C}$ saturation or lower).

*2) Be sure to use auto zero calibration, in the case of 500 ppm or less range.

List of sampling devices (example)

| No. | Device name | Fuji's type |
|-----|-------------------------------|---|
| ① | Mist filter | ZBBK1V03-0 |
| ② | Safety drain trap | ZBH51603 |
| ③ | Pump | ZBG80 |
| ④ | Electronic cooler | ZBC91003 |
| ⑤ | Drain pot | ZBH13003 (Length 255mm) |
| ⑥ | Ball valve | ZBFB1 |
| ⑦ | Two-way solenoid valve | |
| ⑧ | Standard gas for calibration | ZBM□Y04-0□ (Codes in □ to be selected depending on application) |
| ⑨ | Flow meter | ZBD42203 |
| ⑩ | Membrane filter | ZBBM2V03-0 |
| ⑪ | Demister | ZBH35003 |
| ⑫ | NO ₂ /NO converter | ZDL02001 |
| ⑬ | Three-way solenoid valve | |

Note) The above is a typical configuration example. As configuration may differ depending on measuring objects, please consult us.

| Digit | Description | note | 1 | 2 | 3 | 4 | 5 | 6 | 7 | 8 | 9 | 10 | 11 | 12 | 13 | 14 | 15 | 16 | 17 | 18 | 19 | 20 | 21 | 22 | 23 | 24 | 25 | 26 | ← Digit |
|-------|---|-------|---|---|---|---|---|---|---|---|---|----|----|----|----|----|----|----|----|----|----|----|----|----|----|----|----|----|---------|
| 24 | <Unit> ppm, % mg/m ³ , g/m ³ | note7 | Z | R | E | | | | | 1 | | | | | | | | | | | | | | | | | | | |
| 25 | <Adjustment> For standard For heat treatment furnace For converter Others | note8 | | | | | | | | | | | | | | | | | | | | | | | | | | | |
| 26 | <Others> None standard | | | | | | | | | | | | | | | | | | | | | | | | | | | | |

| <RANGE CODE> | |
|--------------|------|
| Range | Code |
| None | Y |
| 0-100ppm | B |
| 0-200ppm | C |
| 0-250ppm | D |
| 0-300ppm | S |
| 0-500ppm | E |
| 0-1000ppm | F |
| 0-2000ppm | G |
| 0-2500ppm | U |
| 0-3000ppm | T |
| 0-5000ppm | H |
| 0-1% | J |
| 0-2% | K |
| 0-3% | Q |
| 0-5% | L |
| 0-10% | M |
| 0-20% | N |
| 0-25% | V |
| 0-40% | W |
| 0-50% | P |
| 0-70% | X |
| 0-100% | R |
| Others | Z |

note1) "A. Cal." must be specified at 22nd digit, in the case of 500 ppm or less range.

note2) When only O₂ measurement is necessary, "Y" should be specified at the 6th digit.

note3) When "1" is specified at 7th digit, O₂ pt sensor signal has to be set as 0-1V DC linear corresponding to full scale.

External zirconia O₂ sensor and external O₂ analyzer are not included in the scope of supply, and has to be separately ordered.

note4) Refer to Tables 1 for possible combination of measuring components and ranges in the data sheet.

When "Y" is specified at 6th digit, "Y" should be specified at 9th to 16th digit.

note5) O₂ correction is calculated only for NO, SO₂ and CO

note6) When 5 components measurement is specified, "H" must not be specified at 22nd digit.

When 4 components measurement is specified and "H" is specified at 22nd digit, 3 point is maximum for alarm output function.

note7) When "B" is specified at 24th digit, measuring range should be specified by ppm range code.

In this case NO, SO₂ and CO measuring range are corresponding range in mg/m³.

Please refer to the table shown below for the corresponding range code based on "mg/m³".

note8) When A to D is specified on the 25th digit, the analyzer will be adjusted and delivered with the following gasses.

Standard "A": balance gas N₂

For heat treatment furnace "C": balance gas 30%H₂ / remains N₂

For converter "D": balance gas CO, CO₂

When other adjustment is required, please specify "Z".

When "Z" is specified, please attach a list of gas composition contained in the measuring gas.

Corresponding mg/m³

| Range code | Unit : ppm | Corresponding range in mg/m ³ | | |
|------------|------------|--|-------------------------|-------------------------|
| | | NO | SO ₂ | CO |
| C | 0-200ppm | 0-260mg/m ³ | 0-570mg/m ³ | 0-250mg/m ³ |
| D | 0-250ppm | 0-325mg/m ³ | 0-700mg/m ³ | 0-300mg/m ³ |
| S | 0-300ppm | 0-400mg/m ³ | 0-850mg/m ³ | 0-375mg/m ³ |
| E | 0-500ppm | 0-650mg/m ³ | 0-1400mg/m ³ | 0-600mg/m ³ |
| F | 0-1000ppm | 0-1300mg/m ³ | 0-2800mg/m ³ | 0-1250mg/m ³ |
| G | 0-2000ppm | 0-2600mg/m ³ | 0-5600mg/m ³ | 0-2500mg/m ³ |
| U | 0-2500ppm | 0-3300mg/m ³ | 0-7100mg/m ³ | 0-3000mg/m ³ |
| T | 0-3000ppm | 0-4000mg/m ³ | 0-8500mg/m ³ | 0-3750mg/m ³ |
| H | 0-5000ppm | 0-6600mg/m ³ | 0-14.00g/m ³ | 0-6250mg/m ³ |

The conversion formula "ppm" unit into "mg/m³" unit.

NO (mg/m³) = 1.34 × NO (ppm)

SO₂ (mg/m³) = 2.86 × SO₂ (ppm)

CO (mg/m³) = 1.25 × CO (ppm)

Table 1 Measurable component and range - availability check table -

Procedure of range selection

On one component analyzer:

First determine 1st range, then select 2nd range from the right of your determination range in following tables.

More than two components:

The procedure is same as one component. Difference is 2nd range in the tables.

The 2nd range in the tables for two and more components is maximum available range.

2nd range is selectable from 1st range to 2nd range(max) on the table.

1-component analyzer : CO

| 1st range | 2nd range |
|-------------|---|
| 0 - 200ppm | None, 0 - 250ppm,300ppm,500ppm,1000ppm,2000ppm |
| 0 - 250ppm | None, 0 - 300ppm,500ppm,1000ppm,2000ppm,2500ppm |
| 0 - 300ppm | None, 0 - 500ppm,1000ppm,2000ppm,2500ppm |
| 0 - 500ppm | None, 0 - 1000ppm,2000ppm,2500ppm,3000ppm,5000ppm |
| 0 - 1000ppm | None, 0 - 2000ppm,2500ppm,3000ppm,5000ppm,1%,2% |
| 0 - 2000ppm | None, 0 - 2500ppm,3000ppm,5000ppm,1%,2% |
| 0 - 2500ppm | None, 0 - 3000ppm,5000ppm,1%,2% |
| 0 - 3000ppm | None, 0 - 5000ppm,1%,2% |
| 0 - 5000ppm | None, 0 - 1%,2%,3%,5% |
| 0 - 1% | None, 0 - 2%,3%,5%,10% |
| 0 - 2% | None, 0 - 3%,5%,10%,20% |
| 0 - 3% | None, 0 - 5%,10%,20%,25% |
| 0 - 5% | None, 0 - 10%,20%,25%,40%,50% |
| 0 - 10% | None, 0 - 20%,25%,40%,50%,70%,100% |
| 0 - 20% | None, 0 - 25%,40%,50%,70%,100% |
| 0 - 25% | None, 0 - 40%,50%,70%,100% |
| 0 - 40% | None, 0 - 50%,70%,100% |
| 0 - 50% | None, 0 - 70%,100% |
| 0 - 70% | None, 0 - 100% |
| 0 - 100% | None |

1-component analyzer : NO

| 1st range | 2nd range |
|-------------|---|
| 0 - 200ppm | None, 0 - 250ppm,300ppm,500ppm,1000ppm,2000ppm |
| 0 - 250ppm | None, 0 - 300ppm,500ppm,1000ppm,2000ppm,2500ppm |
| 0 - 300ppm | None, 0 - 500ppm,1000ppm,2000ppm,2500ppm |
| 0 - 500ppm | None, 0 - 1000ppm,2000ppm,2500ppm,3000ppm,5000ppm |
| 0 - 1000ppm | None, 0 - 2000ppm,2500ppm,3000ppm,5000ppm |
| 0 - 2000ppm | None, 0 - 2500ppm,3000ppm,5000ppm |
| 0 - 2500ppm | None, 0 - 3000ppm,5000ppm |
| 0 - 3000ppm | None, 0 - 5000ppm |
| 0 - 5000ppm | None |

1-component analyzer : SO₂

| 1st range | 2nd range |
|-------------|---|
| 0 - 200ppm | None, 0 - 250ppm,300ppm,500ppm,1000ppm,2000ppm |
| 0 - 250ppm | None, 0 - 300ppm,500ppm,1000ppm,2000ppm,2500ppm |
| 0 - 300ppm | None, 0 - 500ppm,1000ppm,2000ppm,2500ppm |
| 0 - 500ppm | None, 0 - 1000ppm,2000ppm,2500ppm,3000ppm,5000ppm |
| 0 - 1000ppm | None, 0 - 2000ppm,2500ppm,3000ppm,5000ppm,1% |
| 0 - 2000ppm | None, 0 - 2500ppm,3000ppm,5000ppm,1%,2% |
| 0 - 2500ppm | None, 0 - 3000ppm,5000ppm,1%,2% |
| 0 - 3000ppm | None, 0 - 5000ppm,1%,2% |
| 0 - 5000ppm | None, 0 - 1%,2%,3%,5% |
| 0 - 1% | None, 0 - 2%,3%,5%,10% |
| 0 - 2% | None, 0 - 3%,5%,10% |
| 0 - 3% | None, 0 - 10% |
| 0 - 5% | None, 0 - 10% |
| 0 - 10% | None |

1-component analyzer : CO₂

| 1st range | 2nd range |
|-------------|---|
| 0 - 100ppm | None, 0 - 200ppm,250ppm,300ppm,500ppm,1000ppm |
| 0 - 200ppm | None, 0 - 250ppm,300ppm,500ppm,1000ppm,2000ppm |
| 0 - 250ppm | None, 0 - 300ppm,500ppm,1000ppm,2000ppm,2500ppm |
| 0 - 300ppm | None, 0 - 500ppm,1000ppm,2000ppm,2500ppm |
| 0 - 500ppm | None, 0 - 1000ppm,2000ppm,2500ppm,3000ppm,5000ppm |
| 0 - 1000ppm | None, 0 - 2000ppm,2500ppm,3000ppm,5000ppm,1% |
| 0 - 2000ppm | None, 0 - 2500ppm,3000ppm,5000ppm,1%,2% |
| 0 - 2500ppm | None, 0 - 3000ppm,5000ppm,1%,2% |
| 0 - 3000ppm | None, 0 - 5000ppm,1%,2% |
| 0 - 5000ppm | None, 0 - 1%,2%,3%,5% |
| 0 - 1% | None, 0 - 2%,3%,5%,10% |
| 0 - 2% | None, 0 - 3%,5%,10%,20% |
| 0 - 3% | None, 0 - 5%,10%,20%,25% |
| 0 - 5% | None, 0 - 10%,20%,25%,40%,50% |
| 0 - 10% | None, 0 - 20%,25%,40%,50%,70%,100% |
| 0 - 20% | None, 0 - 25%,40%,50%,70%,100% |
| 0 - 25% | None, 0 - 40%,50%,70%,100% |
| 0 - 40% | None, 0 - 50%,70%,100% |
| 0 - 50% | None, 0 - 70%,100% |
| 0 - 70% | None, 0 - 100% |
| 0 - 100% | None |

1-component analyzer : CH₄

| 1st range | 2nd range |
|-------------|---|
| 0 - 500ppm | None, 0 - 1000ppm,2000ppm,2500ppm,3000ppm,5000ppm |
| 0 - 1000ppm | None, 0 - 2000ppm,2500ppm,3000ppm,5000ppm,1% |
| 0 - 2000ppm | None, 0 - 2500ppm,3000ppm,5000ppm,1%,2% |
| 0 - 2500ppm | None, 0 - 3000ppm,5000ppm,1%,2% |
| 0 - 3000ppm | None, 0 - 5000ppm,1%,2% |
| 0 - 5000ppm | None, 0 - 1%,2%,3%,5% |
| 0 - 1% | None, 0 - 2%,3%,5%,10% |
| 0 - 2% | None, 0 - 3%,5%,10%,20% |
| 0 - 3% | None, 0 - 5%,10%,20%,25% |
| 0 - 5% | None, 0 - 10%,20%,25%,40%,50% |
| 0 - 10% | None, 0 - 20%,25%,40%,50%,70%,100% |
| 0 - 20% | None, 0 - 25%,40%,50%,70%,100% |
| 0 - 25% | None, 0 - 40%,50%,70%,100% |
| 0 - 40% | None, 0 - 50%,70%,100% |
| 0 - 50% | None, 0 - 70%,100% |
| 0 - 70% | None, 0 - 100% |
| 0 - 100% | None |

2-component analyzer : NO/SO₂

| 1-component : NO | | 2-component : SO ₂ | |
|------------------|------------------|-------------------------------|------------------|
| 1st range | 2nd range (max.) | 1st range | 2nd range (max.) |
| 0 - 200ppm | 0 - 2000ppm | 0 - 200ppm | 0 - 2000ppm |
| 0 - 250ppm | 0 - 2500ppm | 0 - 250ppm | 0 - 2500ppm |
| 0 - 300ppm | 0 - 2500ppm | 0 - 300ppm | 0 - 2500ppm |
| 0 - 500ppm | 0 - 5000ppm | 0 - 500ppm | 0 - 5000ppm |
| 0 - 1000ppm | 0 - 5000ppm | 0 - 1000ppm | 0 - 5000ppm |
| 0 - 2000ppm | 0 - 5000ppm | 0 - 2000ppm | 0 - 5000ppm |
| 0 - 2500ppm | 0 - 5000ppm | 0 - 2500ppm | 0 - 5000ppm |
| 0 - 3000ppm | 0 - 5000ppm | 0 - 3000ppm | 0 - 5000ppm |
| 0 - 5000ppm | None | 0 - 5000ppm | None |

• The 2nd component should be selected as shown in the right table.

2-component analyzer : NO/CO

| 1-component : NO | | 2-component : CO | |
|------------------|------------------|------------------|------------------|
| 1st range | 2nd range (max.) | 1st range | 2nd range (max.) |
| 0 - 200ppm | 0 - 2000ppm | 0 - 200ppm | 0 - 2000ppm |
| 0 - 250ppm | 0 - 2500ppm | 0 - 250ppm | 0 - 2500ppm |
| 0 - 300ppm | 0 - 2500ppm | 0 - 300ppm | 0 - 2500ppm |
| 0 - 500ppm | 0 - 5000ppm | 0 - 500ppm | 0 - 5000ppm |
| 0 - 1000ppm | 0 - 5000ppm | 0 - 1000ppm | 0 - 5000ppm |
| 0 - 2000ppm | 0 - 5000ppm | 0 - 2000ppm | 0 - 5000ppm |
| 0 - 2500ppm | 0 - 5000ppm | 0 - 2500ppm | 0 - 5000ppm |
| 0 - 3000ppm | 0 - 5000ppm | 0 - 3000ppm | 0 - 5000ppm |
| 0 - 5000ppm | None | 0 - 5000ppm | None |

• The 2nd component should be selected as shown in the right table.

2-component analyzer : CO₂/CH₄

| 1-component : CO ₂ | | 2-component : CH ₄ | |
|-------------------------------|------------------|---|--|
| 1st range | 2nd range (max.) | 1st range/2nd range (max.) | |
| 0-100ppm | 0-1000ppm | 0-500/5000ppm, 0-1000/5000ppm, 0-2000/5000ppm, 0-2500/5000ppm, 0-3000/5000ppm, 0-5000ppm | |
| 0-200ppm | 0-2000ppm | 0-500/5000ppm, 0-1000ppm/1%, 0-2000ppm/1%, 0-2500ppm/1%, 0-3000ppm/1%, 0-5000ppm/1%, 0-1% | |
| 0-250ppm | 0-2500ppm | | |
| 0-300ppm | 0-2500ppm | | |
| 0-500ppm | 0-2500ppm | 0-500/5000ppm, 0-1000ppm/1%, 0-2000ppm/2%, 0-2500ppm/2%, 0-3000ppm/2%, 0-5000ppm/2%, 0-1/2%, 0-2/10%, 0-3/10%, 0-5/10%, 0-10% | |
| 0-500ppm | 0-5000ppm | 0-1000ppm/1%, 0-2000ppm/2%, 0-2500ppm/2%, 0-3000ppm/2%, 0-5000ppm/2%, 0-1/2%, 0-2/10%, 0-3/10%, 0-5/10%, 0-10% | |
| 0-1000ppm | 0-2500ppm | 0-500/5000ppm, 0-1000ppm/1%, 0-2000ppm/2%, 0-2500ppm/2%, 0-3000ppm/2%, 0-5000ppm/2%, 0-1/3%, 0-2/20%, 0-3/20%, 0-5/20%, 0-10/20%, 0-20% | |
| 0-1000ppm | 0-5000ppm | 0-1000ppm/1%, 0-2000ppm/2%, 0-2500ppm/2%, 0-3000ppm/2%, 0-5000ppm/3%, 0-1/3%, 0-2/20%, 0-3/20%, 0-5/20%, 0-10/20%, 0-20% | |
| 0-1000ppm | 0-1% | 0-2000ppm/2%, 0-2500ppm/2%, 0-3000ppm/2%, 0-5000ppm/3%, 0-1/3%, 0-2/20%, 0-3/20%, 0-5/20%, 0-10/20%, 0-20% | |
| 0-2000ppm | 0-2500ppm | 0-500/5000ppm, 0-1000ppm/1%, 0-2000ppm/2%, 0-2500ppm/2%, 0-3000ppm/2%, 0-5000ppm/5%, 0-1/5%, 0-2/20%, 0-3/20%, 0-5/20%, 0-10/20%, 0-20% | |
| 0-2000ppm | 0-5000ppm | 0-1000ppm/1%, 0-2000ppm/2%, 0-2500ppm/2%, 0-3000ppm/2%, 0-5000ppm/5%, 0-1/5%, 0-2/20%, 0-3/20%, 0-5/20%, 0-10/20%, 0-20% | |
| 0-2000ppm | 0-2% | 0-2000ppm/2%, 0-2500ppm/2%, 0-3000ppm/2%, 0-5000ppm/5%, 0-1/5%, 0-2/20%, 0-3/20%, 0-5/20%, 0-10/20%, 0-20% | |
| 0-2500ppm | 0-5000ppm | 0-1000ppm/1%, 0-2000ppm/2%, 0-2500ppm/2%, 0-3000ppm/2%, 0-5000ppm/5%, 0-1/5%, 0-2/20%, 0-3/20%, 0-5/25%, 0-10/25%, 0-20/25%, 0-25% | |
| 0-2500ppm | 0-2% | 0-2000ppm/2%, 0-2500ppm/2%, 0-3000ppm/2%, 0-5000ppm/5%, 0-1/5%, 0-2/20%, 0-3/20%, 0-5/25%, 0-10/25%, 0-20/25%, 0-25% | |
| 0-3000ppm | 0-2% | 0-1000ppm/1%, 0-2000ppm/2%, 0-2500ppm/2%, 0-3000ppm/2%, 0-5000ppm/5%, 0-1/5%, 0-2/20%, 0-3/20%, 0-5/25%, 0-10/25%, 0-20/25%, 0-25% | |
| 0-5000ppm | 0-3% | 0-500/5000ppm, 0-1000ppm/1%, 0-2000ppm/2%, 0-2500ppm/2%, 0-3000ppm/2%, 0-5000ppm/2%, 0-1/10%, 0-2/20%, 0-3/20%, 0-5/50%, 0-10/50%, 0-20/50%, 0-25/50%, 0-40/50%, 0-50% | |
| 0-5000ppm | 0-5% | 0-500/5000ppm, 0-1000ppm/1%, 0-2000ppm/2%, 0-2500ppm/2%, 0-3000ppm/2%, 0-5000ppm/2%, 0-1/10%, 0-2/20%, 0-3/20%, 0-5/50%, 0-10/50%, 0-20/50%, 0-25/50%, 0-40/50%, 0-50% | |
| 0-1% | 0-10% | 0-500/5000ppm, 0-1000ppm/1%, 0-2000ppm/2%, 0-2500ppm/2%, 0-3000ppm/2%, 0-5000ppm/2%, 0-1/10%, 0-2/20%, 0-3/25%, 0-5/50%, 0-10/50%, 0-20/50%, 0-25/50%, 0-40/50%, 0-50% | |
| 0-2% | 0-20% | 0-500/5000ppm, 0-1000ppm/1%, 0-2000ppm/2%, 0-2500ppm/2%, 0-3000ppm/2%, 0-5000ppm/2%, 0-1/10%, 0-2/10%, 0-3/10%, 0-5/25%, 0-10/100%, 0-20/100%, 0-25/100%, 0-40/100%, 0-50/100%, 0-70/100%, 0-100% | |
| 0-2% | 0-10% | 0-500/5000ppm, 0-1000ppm/1%, 0-2000ppm/2%, 0-2500ppm/2%, 0-3000ppm/2%, 0-5000ppm/2%, 0-1/10%, 0-2/20%, 0-3/25%, 0-5/50%, 0-10/100%, 0-20/100%, 0-25/100%, 0-40/100%, 0-50/100%, 0-70/100%, 0-100% | |
| 0-3% | 0-25% | 0-500/5000ppm, 0-1000ppm/1%, 0-2000ppm/2%, 0-2500ppm/2%, 0-3000ppm/2%, 0-5000ppm/2%, 0-1/10%, 0-2/20%, 0-3/25%, 0-5/25%, 0-10/100%, 0-20/100%, 0-25/100%, 0-40/100%, 0-50/100%, 0-70/100%, 0-100% | |
| 0-5% | 0-20% | 0-500/5000ppm, 0-1000ppm/1%, 0-2000ppm/2%, 0-2500ppm/2%, 0-3000ppm/2%, 0-5000ppm/2%, 0-1/10%, 0-2/20%, 0-3/25%, 0-5/50%, 0-10/100%, 0-20/100%, 0-25/100%, 0-40/100%, 0-50/100%, 0-70/100%, 0-100% | |
| 0-5% | 0-50% | 0-1000ppm/1%, 0-2000ppm/2%, 0-2500ppm/2%, 0-3000ppm/2%, 0-5000ppm/2%, 0-1/10%, 0-2/20%, 0-3/25%, 0-5/50%, 0-10/50%, 0-20/100%, 0-25/100%, 0-40/100%, 0-50/100%, 0-70/100%, 0-100% | |
| 0-10% | 0-20% | 0-500/5000ppm, 0-1000ppm/1%, 0-2000ppm/2%, 0-2500ppm/2%, 0-3000ppm/2%, 0-5000ppm/2%, 0-1/10%, 0-2/20%, 0-3/25%, 0-5/50%, 0-10/100%, 0-20/100%, 0-25/100%, 0-40/100%, 0-50/100%, 0-70/100%, 0-100% | |
| 0-10% | 0-50% | 0-1000ppm/1%, 0-2000ppm/2%, 0-2500ppm/2%, 0-3000ppm/2%, 0-5000ppm/2%, 0-1/10%, 0-2/20%, 0-3/25%, 0-5/50%, 0-10/100%, 0-20/100%, 0-25/100%, 0-40/100%, 0-50/100%, 0-70/100%, 0-100% | |
| 0-20% | 0-100% | 0-2000ppm/2%, 0-2500ppm/2%, 0-3000ppm/2%, 0-5000ppm/2%, 0-1/10%, 0-2/10%, 0-3/10%, 0-5/50%, 0-10/100%, 0-20/100%, 0-25/100%, 0-40/100%, 0-50/100%, 0-70/100%, 0-100% | |
| 0-20% | 0-100% | 0-2000ppm/2%, 0-2500ppm/2%, 0-3000ppm/2%, 0-5000ppm/2%, 0-1/10%, 0-2/10%, 0-3/25%, 0-5/50%, 0-10/100%, 0-20/100%, 0-25/100%, 0-40/100%, 0-50/100%, 0-70/100%, 0-100% | |
| 0-25% | 0-100% | 0-2000ppm/2%, 0-2500ppm/2%, 0-3000ppm/2%, 0-5000ppm/2%, 0-1/10%, 0-2/20%, 0-3/25%, 0-5/50%, 0-10/100%, 0-20/100%, 0-25/100%, 0-40/100%, 0-50/100%, 0-70/100%, 0-100% | |
| 0-40% | | | |
| 0-50% | | | |
| 0-70% | | | |
| 0-100% | None | | |

3-component analyzer : NO/SO₂/CO >>> Combination of 1st component NO and 2nd component SO₂ / 3rd component CO

| 1-component : NO | | + | 2-component : SO ₂ | | 3-component : CO | |
|------------------|------------------|-----------|-------------------------------|------------------|---|--|
| 1st range | 2nd range (max.) | | 1st range | 2nd range (max.) | 1st range/2nd range (max.) | |
| 0-200ppm | 0-2000ppm | | 0-200ppm | 0-2000ppm | 0-200/2000ppm, 0-250/2500ppm, 0-300/2500ppm, 0-500/2500ppm, 0-1000/2500ppm, 0-2000/2500ppm, 0-2500ppm | |
| 0-250ppm | 0-2500ppm | | 0-250ppm | 0-2500ppm | | |
| 0-300ppm | 0-2500ppm | | 0-300ppm | | | |
| 0-500ppm | 0-5000ppm | | 0-500ppm | 0-2500ppm | 0-200/2000ppm, 0-250/2500ppm, 0-300/2500ppm, 0-500/5000ppm, 0-1000/5000ppm, 0-2000/5000ppm, 0-5000ppm | |
| 0-1000ppm | 0-5000ppm | | 0-1000ppm | | | |
| 0-2000ppm | 0-5000ppm | | 0-2500ppm | None | | |
| 0-2500ppm | 0-5000ppm | | 0-1000ppm | 0-5000ppm | 0-500/5000ppm, 0-1000/5000ppm, 0-2000/5000ppm, 0-2500/5000ppm, 0-3000/5000ppm, 0-5000ppm | |
| 0-3000ppm | 0-5000ppm | | 0-2000ppm | | | |
| 0-5000ppm | None | | 0-2500ppm | | | |
| | | | 0-3000ppm | | | |
| | | 0-5000ppm | None | | | |

3-component analyzer : CO₂/CO/CH₄ >>> Combination of 1st component CO₂ / 2nd component CO and 3rd component CH₄

| 1-component : CO ₂ | | 2-component : CO | | + | 3-component : CH ₄ | | Availability of product |
|-------------------------------|------------------|---|--|--------|-------------------------------|------------------|---|
| 1st range | 2nd range (max.) | 1st range/2nd range (max.) | | | 1st range | 2nd range (max.) | |
| 0-5000ppm | 0-3% | 0-500/5000ppm, 0-1000ppm/1%, 0-2000ppm/2%, 0-2500ppm/2%, 0-3000ppm/2%, 0-5000ppm/5%, 0-1/10%, 0-2/20%, 0-3/25%, 0-5/50%, 0-10/100%, 0-20/100%, 0-25/100%, 0-40/100%, 0-50/100%, 0-70/100%, 0-100% | | | 0-5000ppm | 0-5% | Product available only when CO analyzer max. measuring range is 50% or less |
| 0-1% | 0-5% | | | | 0-1% | 0-10% | Product available |
| 0-2% | 0-5% | | | | 0-2% | 0-20% | |
| 0-5000ppm | 0-5% | 0-500/5000ppm, 0-1000ppm/1%, 0-2000ppm/2%, 0-2500ppm/2%, 0-3000ppm/2%, 0-5000ppm/5%, 0-1/10%, 0-2/20%, 0-3/25%, 0-5/50%, 0-10/100%, 0-20/100%, 0-25/100%, 0-40/100%, 0-50/100%, 0-70/100%, 0-100% | | | 0-3% | 0-25% | Product available only when CO analyzer measuring range is 0 to 1000ppm or more. |
| 0-1% | 0-10% | 0-500/5000ppm, 0-1000ppm/1%, 0-2000ppm/2%, 0-2500ppm/2%, 0-3000ppm/2%, 0-5000ppm/5%, 0-1/10%, 0-2/20%, 0-3/25%, 0-5/25%, 0-10/100%, 0-20/100%, 0-25/100%, 0-40/100%, 0-50/100%, 0-70/100%, 0-100% | | | 0-5% | 0-10% | |
| 0-2% | 0-20% | 0-500/5000ppm, 0-1000ppm/1%, 0-2000ppm/2%, 0-2500ppm/2%, 0-3000ppm/2%, 0-5000ppm/5%, 0-1/10%, 0-2/20%, 0-3/25%, 0-5/50%, 0-10/50%, 0-20/100%, 0-25/100%, 0-40/100%, 0-50/100%, 0-70/100%, 0-100% | | | 0-10% | 0-20% | Product available only when CO analyzer measuring range is 0 to 5000ppm or more. |
| 0-2% | 0-10% | 0-500/5000ppm, 0-1000ppm/1%, 0-2000ppm/2%, 0-2500ppm/2%, 0-3000ppm/2%, 0-5000ppm/5%, 0-1/10%, 0-2/20%, 0-3/25%, 0-5/50%, 0-10/100%, 0-20/100%, 0-25/100%, 0-40/100%, 0-50/100%, 0-70/100%, 0-100% | | | 0-20% | 0-25% | |
| 0-3% | 0-25% | 0-3/25%, 0-5/50%, 0-10/100%, 0-20/100%, 0-25/100%, 0-40/100%, 0-50/100%, 0-70/100%, 0-100% | | | 0-25% | 0-40% | Product available only when CO analyzer measuring range is 0 to 5000ppm or more. |
| 0-5% | 0-50% | | | | 0-40% | 0-50% | |
| 0-10% | 0-100% | 0-1000ppm/1%, 0-2000ppm/1%, 0-2500ppm/1%, 0-3000ppm/2%, 0-5000ppm/5%, 0-1/10%, 0-2/20%, 0-3/25%, 0-5/50%, 0-10/100%, 0-20/100%, 0-25/100%, 0-40/100%, 0-50/100%, 0-70/100%, 0-100% | | | 0-50% | 0-70% | Product available only when CO analyzer measuring range is more than 5000ppm or CO ₂ analyzer range is more than 2%. |
| 0-20% | | | | 0-70% | 0-100% | | |
| 0-25% | | | | 0-100% | None | | |
| 0-40% | | | | | | | |
| 0-50% | | | | | | | |
| 0-70% | | | | | | | |
| 0-100% | None | | | | | | |

4-component analyzer : NO/SO₂/CO₂/CO

| | | | | | | | | | | |
|------------------|------------------|-------------|-------------------------------|------------------|------|-------------------------------|------------------|---|------------------|------------------|
| 1-component : NO | | + | 2-component : SO ₂ | | + | 3-component : CO ₂ | | + | 4-component : CO | |
| 1st range | 2nd range (max.) | | 1st range | 2nd range (max.) | | 1st range | 2nd range (max.) | | 1st range | 2nd range (max.) |
| 0 - 200ppm | 0 - 2000ppm | | 0 - 200ppm | 0 - 2000ppm | | 0 - 1% | 0 - 10% | | 0 - 200ppm | 0 - 2000ppm |
| 0 - 250ppm | 0 - 2500ppm | | 0 - 250ppm | 0 - 2500ppm | | 0 - 2% | 0 - 20% | | 0 - 250ppm | 0 - 2500ppm |
| 0 - 300ppm | 0 - 2500ppm | | 0 - 300ppm | 0 - 2500ppm | | 0 - 3% | 0 - 25% | | 0 - 300ppm | 0 - 2500ppm |
| 0 - 500ppm | 0 - 5000ppm | | 0 - 500ppm | 0 - 5000ppm | | 0 - 5% | 0 - 50% | | 0 - 500ppm | 0 - 2500ppm |
| 0 - 1000ppm | 0 - 5000ppm | | 0 - 1000ppm | 0 - 5000ppm | | 0 - 10% | 0 - 50% | | 0 - 1000ppm | 0 - 2500ppm |
| 0 - 2000ppm | 0 - 5000ppm | | 0 - 2000ppm | 0 - 5000ppm | | 0 - 20% | 0 - 50% | | 0 - 2000ppm | 0 - 2500ppm |
| 0 - 2500ppm | 0 - 5000ppm | | 0 - 2500ppm | 0 - 5000ppm | | 0 - 25% | 0 - 50% | | 0 - 2500ppm | 0 - 2500ppm |
| 0 - 3000ppm | 0 - 5000ppm | | 0 - 3000ppm | 0 - 5000ppm | | 0 - 25% | 0 - 50% | | 0 - 2500ppm | 0 - 2500ppm |
| 0 - 5000ppm | None | 0 - 5000ppm | None | 0 - 50% | None | 0 - 2500ppm | None | | | |

Table 2 Channel (Ch) No. and display/output contents comparison table

| Code symbol | | | Display/output contents |
|-------------|-----------|------------|---|
| 6th digit | 7th digit | 21st digit | |
| Y | 1 to 3 | Y | Ch1:O ₂ |
| P | Y | Y | Ch1:NO |
| A | Y | Y | Ch1:SO ₂ |
| D | Y | Y | Ch1:CO ₂ |
| B | Y | Y | Ch1:CO |
| E | Y | Y | Ch1:CH ₄ |
| F | Y | Y | Ch1:NO, Ch2:SO ₂ |
| G | Y | Y | Ch1:NO, Ch2:CO |
| J | Y | Y | Ch1:CO ₂ , Ch2:CO |
| K | Y | Y | Ch1:CH ₄ , Ch2:CO |
| L | Y | Y | Ch1:CO ₂ , Ch2:CH ₄ |
| N | Y | Y | Ch1:NO, Ch2:SO ₂ , Ch3:CO |
| T | Y | Y | Ch1:CO ₂ , Ch2:CO, Ch3:CH ₄ |
| V | Y | Y | Ch1:NO, Ch2:SO ₂ , Ch3:CO ₂ , Ch4:CO |
| P | 1 to 3 | Y | Ch1:NO, Ch2:O ₂ |
| A | 1 to 3 | Y | Ch1:SO ₂ , Ch2:O ₂ |
| D | 1 to 3 | Y | Ch1:CO ₂ , Ch2:O ₂ |
| B | 1 to 3 | Y | Ch1:CO, Ch2:O ₂ |
| E | 1 to 3 | Y | Ch1:CH ₄ , Ch2:O ₂ |
| F | 1 to 3 | Y | Ch1:NO, Ch2:SO ₂ , Ch3:O ₂ |
| G | 1 to 3 | Y | Ch1:NO, Ch2:CO, Ch3:O ₂ |
| J | 1 to 3 | Y | Ch1:CO ₂ , Ch2:CO, Ch3:O ₂ |
| K | 1 to 3 | Y | Ch1:CH ₄ , Ch2:CO, Ch3:O ₂ |
| L | 1 to 3 | Y | Ch1:CO ₂ , Ch2:CH ₄ , Ch3:O ₂ |
| N | 1 to 3 | Y | Ch1:NO, Ch2:SO ₂ , Ch3:CO, Ch4:O ₂ |
| T | 1 to 3 | Y | Ch1:CO ₂ , Ch2:CO, Ch3:CH ₄ , Ch4:O ₂ |
| V | 1 to 3 | Y | Ch1:NO, Ch2:SO ₂ , Ch3:CO ₂ , Ch4:CO, Ch5:O ₂ |
| P | 1 to 3 | A * | Ch1:NO _x , Ch2:O ₂ , Ch3:corrected NO _x |
| A | 1 to 3 | A * | Ch1:SO ₂ , Ch2:O ₂ , Ch3:corrected SO ₂ |
| B | 1 to 3 | A * | Ch1:CO, Ch2:O ₂ , Ch3:corrected CO |
| F | 1 to 3 | A * | Ch1:NO _x , Ch2:SO ₂ , Ch3:O ₂ , Ch4:corrected NO _x , Ch5:corrected SO ₂ |
| G | 1 to 3 | A * | Ch1:NO _x , Ch2:CO, Ch3:O ₂ , Ch4:corrected NO _x , Ch5:corrected CO |
| J | 1 to 3 | A * | Ch1:CO ₂ , Ch2:CO, Ch3:O ₂ , Ch4:corrected CO |
| N | 1 to 3 | A * | Ch1:NO _x , Ch2:SO ₂ , Ch3:CO, Ch4:O ₂ , Ch5:corrected NO _x , Ch6:corrected SO ₂ , Ch7:corrected CO |
| V | 1 to 3 | A * | Ch1:NO _x , Ch2:SO ₂ , Ch3:CO ₂ , Ch4:CO, Ch5:O ₂ , Ch6:corrected NO _x , Ch7:corrected SO ₂ , Ch8:corrected CO |
| P | 1 to 3 | C * | Ch1:NO _x , Ch2:O ₂ , Ch3:corrected NO _x , Ch4:corrected NO _x average |
| A | 1 to 3 | C * | Ch1:SO ₂ , Ch2:O ₂ , Ch3:corrected SO ₂ , Ch4:corrected SO ₂ average |
| B | 1 to 3 | C * | Ch1:CO, Ch2:O ₂ , Ch3:corrected CO, Ch4:corrected CO average |
| F | 1 to 3 | C * | Ch1:NO _x , Ch2:SO ₂ , Ch3:O ₂ , Ch4:corrected NO _x , Ch5:corrected SO ₂ , Ch6:corrected NO _x average, Ch7:corrected SO ₂ average |
| G | 1 to 3 | C * | Ch1:NO _x , Ch2:CO, Ch3:O ₂ , Ch4:corrected NO _x , Ch5:corrected CO, Ch6:corrected NO _x average, Ch7:corrected CO average |
| J | 1 to 3 | C * | Ch1:CO ₂ , Ch2:CO, Ch3:O ₂ , Ch4:corrected CO, Ch5:corrected CO average |
| N | 1 to 3 | C * | Ch1:NO _x , Ch2:SO ₂ , Ch3:CO, Ch4:O ₂ , Ch5:corrected NO _x , Ch6:corrected SO ₂ , Ch7:corrected CO, Ch8:corrected NO _x average, Ch9:corrected SO ₂ average, Ch10:corrected CO average |
| V | 1 to 3 | C * | Ch1:NO _x , Ch2:SO ₂ , Ch3:CO ₂ , Ch4:CO, Ch5:O ₂ , Ch6:corrected NO _x , Ch7:corrected SO ₂ , Ch8:corrected CO, Ch9:corrected NO _x average, Ch10:corrected SO ₂ average, Ch11:corrected CO average |

* When the 21st digit code is A or C, the component of the NO analyzer is displayed as NO_x.

OUTLINE DIAGRAMS (Unit : mm)

<Top view>

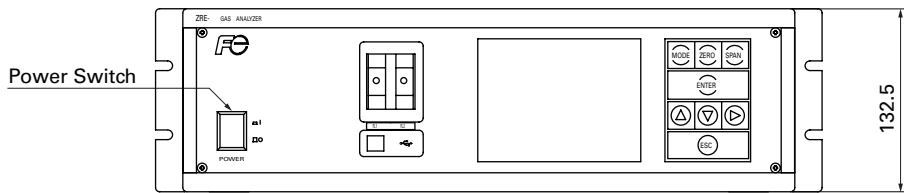
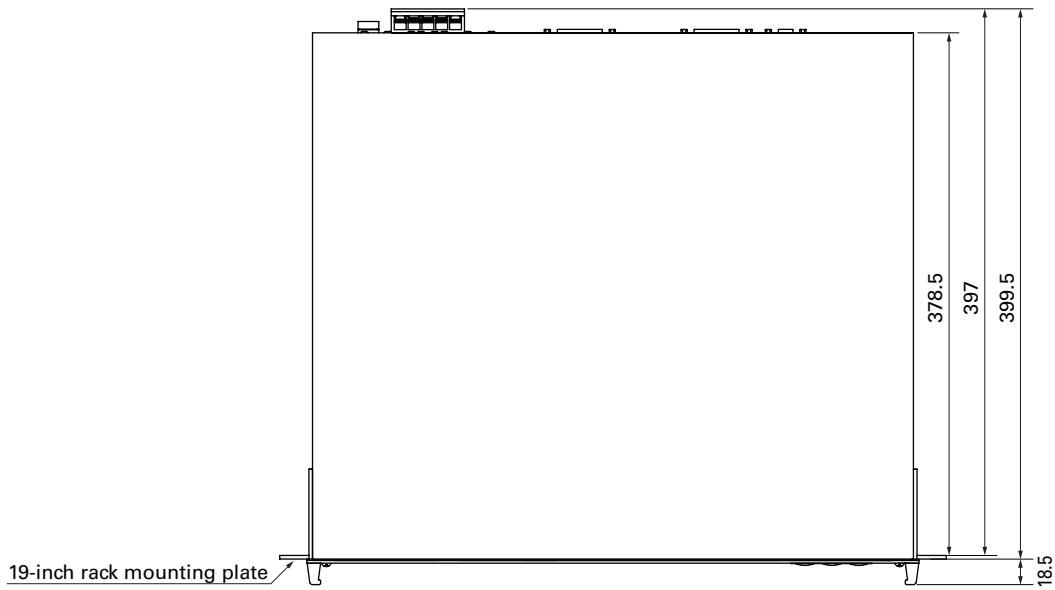

<Front view>

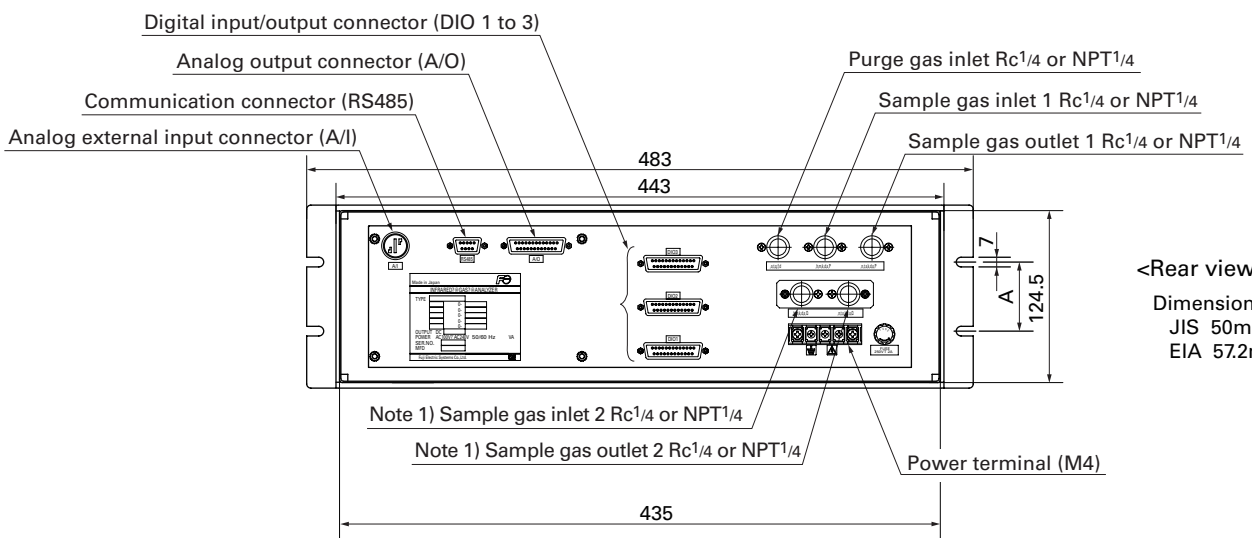

<Rear view>
Dimension A
JIS 50mm
EIA 57.2mm

Note 1) Used for special case.

Mounting method

The analyzer weight should be supported at the bottom of the case.

Panel mounting type

<Panel cutout dimensions>

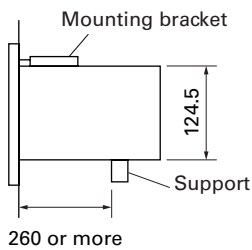
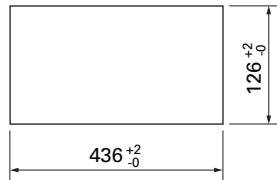

* 70% or more of the analyzer weight should be supported at the bottom of the case. (In case of mounting panel or 19-inch rack provide a support at the end of casing.)

19-inch rack mounting type

<Rack dimensions>

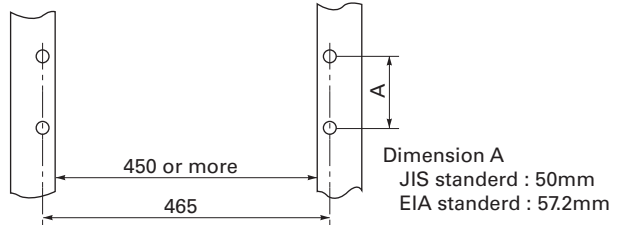

Mounting diagram

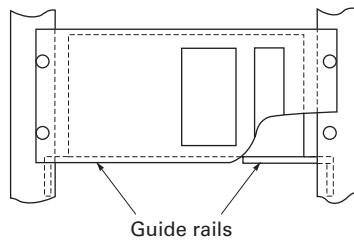
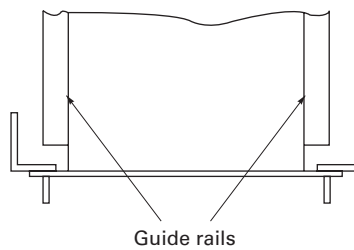

EXTERNAL CONNECTION

<Analog output> A/O connector

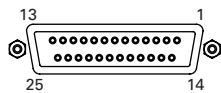

D-sub 25pins female

* In standard, displayed Channel No. and Analog Output No. are same.

- ① ——— AO1+
- ② ——— AO1-
- ③ ——— AO2+
- ④ ——— AO2-
- ⑤ ——— AO3+
- ⑥ ——— AO3-
- ⑦ ——— AO4+
- ⑧ ——— AO4-
- ⑨ ——— AO5+
- ⑩ ——— AO5-
- ⑪ ——— AO6+
- ⑫ ——— AO6-
- ⑬ ——— AO7+
- ⑭ ——— AO7-
- ⑮ ——— AO8+
- ⑯ ——— AO8-
- ⑰ ——— AO9+
- ⑱ ——— AO9-
- ⑲ ——— AO10+
- ⑳ ——— AO10-
- ㉑ ——— AO11+
- ㉒ ——— AO11-
- ㉓ ——— AO12+
- ㉔ ——— AO12-
- ㉕ ——— NC

<RS485 communication signal>

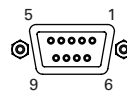

D-sub 9pins female

- ① ——— (GND)
- ② ——— RT×D+
- ③ ——— RT×D-
- ④
- ⑤
- ⑥
- ⑦
- ⑧
- ⑨

<Power terminal>

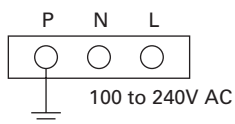

<Analog input> A/I connector (O₂ signal input)

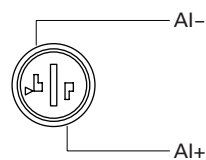

<Digital I/O> DIO 1 to 3 connector (option)

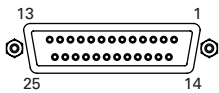

D-sub 25pins female

* DIO 1 to 3 are all as same connector.

Contents of digital input signal

| | |
|-----|---------------------|
| DI1 | Remote hold |
| DI2 | Average value reset |
| DI3 | A. cal. start |
| DI4 | A. zero. cal. start |
| DI5 | Remote range Ch1 |
| DI6 | Remote range Ch2 |
| DI7 | Remote range Ch3 |
| DI8 | Remote range Ch4 |
| DI9 | Remote range Ch5 |

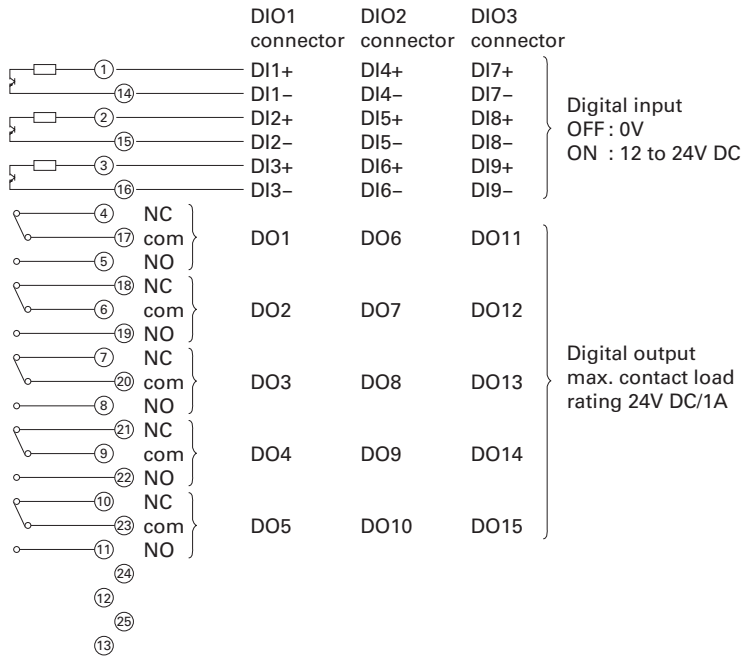

Contents of digital output signal

| | Independent on the number of component | 1-component analyzer | | 2-component analyzer | 3-component analyzer |
|--------------|--|----------------------|--------------------------|----------------------------|----------------------------|
| 22th digit → | A,C | B,E | D,F,G,H | B,D,E,F,G,H | B,D,E,F,G,H |
| DO1 | Instrument error | Instrument error | Instrument error | Instrument error | Instrument error |
| DO2 | Calibration error | Calibration error | Calibration error | Calibration error | Calibration error |
| DO3 | | A.cal.status | (A.cal.status) | (A.cal.status) | (A.cal.status) |
| DO4 | | For zero gas | (For zero gas) | (For zero gas) | (For zero gas) |
| DO5 | | For span gas Ch1 | (For span gas Ch1) | (For span gas Ch1) | (For span gas Ch1) |
| DO6 | (Alarm1) | (Alarm1) | | (For span gas Ch2) | (For span gas Ch2) |
| DO7 | (Alarm2) | (Alarm2) | | | (For span gas Ch3) |
| DO8 | (Alarm3) | (Alarm3) | | | (Range identification Ch1) |
| DO9 | (Alarm4) | (Alarm4) | | (Range identification Ch1) | (Range identification Ch2) |
| DO10 | (Alarm5) | (Alarm5) | Range identification Ch1 | (Range identification Ch2) | (Range identification Ch3) |
| DO11 | | | (Alarm1) | (Alarm1) | (Alarm1) |
| DO12 | | | (Alarm2) | (Alarm2) | (Alarm2) |
| DO13 | | | (Alarm3) | (Alarm3) | (Alarm3) |
| DO14 | | | (Alarm4) | (Alarm4) | (Alarm4) |
| DO15 | | | (Alarm5) | (Alarm5) | (Alarm5) |

The items in the parentheses may not be available depending on the selected type on 22th digit.

The normal open side (NO) of digital output is close when the function is active without range ID.

In case of range ID, normal open (NO) side is close with Lo-range.

The normal close (NC) side is close with Hi-range.

| | 4-component analyzer | | | | 5-component analyzer | | |
|--------------|----------------------|--------------------------|--------------------------|--------------------------|----------------------|--------------------------|--------------------------|
| 22th digit → | B,E | D,F | G | H | B,E | D,F | G |
| DO1 | Instrument error | Instrument error | Instrument error | Instrument error | Instrument error | Instrument error | Instrument error |
| DO2 | Calibration error | Calibration error | Calibration error | Calibration error | Calibration error | Calibration error | Calibration error |
| DO3 | A.cal.status | | A.cal.status | A.cal.status | A.cal.status | | A.cal.status |
| DO4 | For zero gas | | For zero gas | For zero gas | For zero gas | | For zero gas |
| DO5 | For span gas Ch1 | | For span gas Ch1 | For span gas Ch1 | For span gas Ch1 | | For span gas Ch1 |
| DO6 | For span gas Ch2 | | For span gas Ch2 | For span gas Ch2 | For span gas Ch2 | Range identification Ch1 | For span gas Ch2 |
| DO7 | For span gas Ch3 | Range identification Ch1 | For span gas Ch3 | For span gas Ch3 | For span gas Ch3 | Range identification Ch2 | For span gas Ch3 |
| DO8 | For span gas Ch4 | Range identification Ch2 | For span gas Ch4 | For span gas Ch4 | For span gas Ch4 | Range identification Ch3 | For span gas Ch4 |
| DO9 | | Range identification Ch3 | | Range identification Ch1 | For span gas Ch5 | Range identification Ch4 | For span gas Ch5 |
| DO10 | | Range identification Ch4 | | Range identification Ch2 | | Range identification Ch5 | |
| DO11 | (Alarm1) | (Alarm1) | | (Alarm1) | (Alarm1) | (Alarm1) | Range identification Ch1 |
| DO12 | (Alarm2) | (Alarm2) | Range identification Ch1 | (Alarm2) | (Alarm2) | (Alarm2) | Range identification Ch2 |
| DO13 | (Alarm3) | (Alarm3) | Range identification Ch2 | (Alarm3) | (Alarm3) | (Alarm3) | Range identification Ch3 |
| DO14 | (Alarm4) | (Alarm4) | Range identification Ch3 | Range identification Ch3 | (Alarm4) | (Alarm4) | Range identification Ch4 |
| DO15 | (Alarm5) | (Alarm5) | Range identification Ch4 | Range identification Ch4 | (Alarm5) | (Alarm5) | Range identification Ch5 |

SCOPE OF DELIVERY

- Gas analyzer ... 1 unit
- Replacement fuse (250V, 2A AC, delay type) ... 2 pcs
- Instruction manual ... 1 copy
- Connector for I/O connection ... 1 set
- Panel mounting fixtures (in case panel mounting) ... 2 pcs

ORDERING INFORMATION

1. Code symbols
2. Application and composition of sample gas

OUTLINE DIAGRAM (Unit:mm)

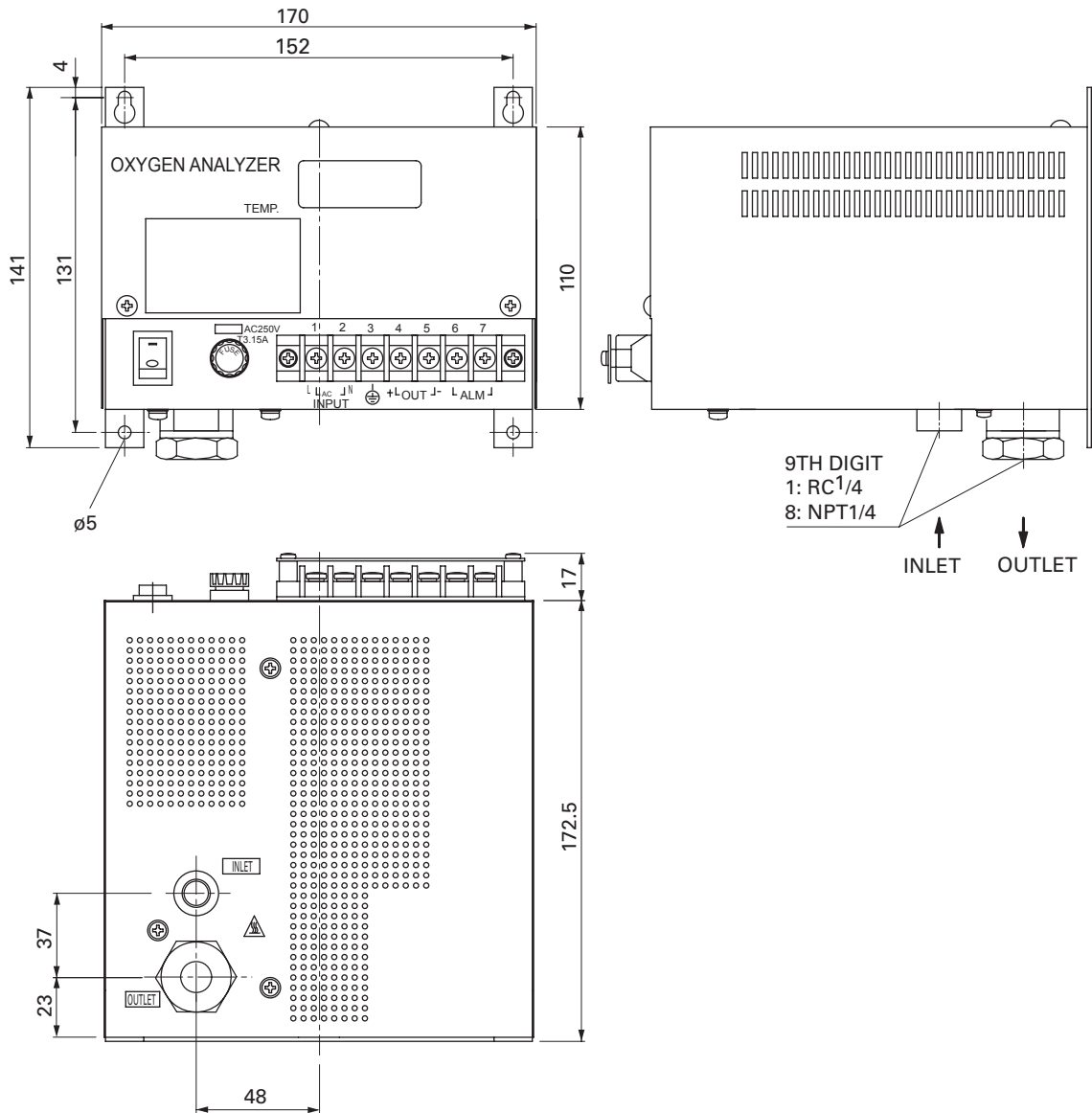

EXTERNAL CONNECTION DIAGRAM

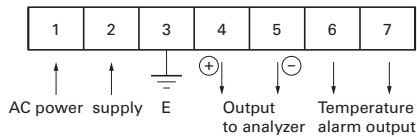

⚠ Caution on Safety

*Before using this product, be sure to read its instruction manual in advance.

Fuji Electric Systems Co., Ltd.

**Sales Div. III, International Sales Group
Global Business Group**

Gate City Ohsaki, East Tower, 11-2, Osaki 1-chome,
Shinagawa-ku, Tokyo 141-0032, Japan

<http://www.fesys.co.jp/eng>

Phone: 81-3-5435-7280, 7281 Fax: 81-3-5435-7425

<http://www.fic-net.jp/eng>