



Instruction Manual

PARAMAGNETIC OXYGEN ANALYZER

TYPE: ZKG



PREFACE

We are grateful for your purchase of Fuji Electric's paramagnetic oxygen analyzer (ZKG).

- First read this instruction manual carefully until an adequate understanding is acquired, and then proceed to installation, operation and maintenance of the gas analyzer. Wrong handling may cause an accident or injury.
- The specifications of this analyzer will be changed without prior notice for further product improvement.
- Modification of this gas analyzer is strictly prohibited unless a written approval is obtained from the manufacturer. Fuji Electric will not bear any responsibility for a trouble caused by such a modification.
- This instruction manual shall be stored by the person who actually uses the gas analyzer.
- After reading the manual, be sure to store it at a place easier to access.
- This instruction manual should be delivered to the end user without fail.

Delivered items

Name	Q'ty	Remarks
Analyzer main frame	1	—
Panel mounting bracket	2	
Fuse	2	250V AC 0.5A delay type
Instruction manual	1	—

Manufacturer: Fuji Electric Instrumentation Co., Ltd.
Type: Described in nameplate on main frame
Date of manufacture: Described in nameplate on main frame
Product nationality: Japan

Request

- It is prohibited to transfer part or all of this manual without Fuji Electric's permission in written format.
- Description in this manual will be changed without prior notice for further improvement.

© Fuji Electric Systems Co., Ltd. 2003

Issued in March, 2003

CONTENTS



PREFACE	i
Caution on safety	iii
1. GENERAL AND PRINCIPLE OF OPERATION	1
1.1 General	1
1.2 Principle of measurement	1
2. NAME AND EXPLANATION OF EACH PART	3
2.1 Name and explanation of each part	3
3. INSTALLATION	4
3.1 Mounting	4
3.1.1 Outline diagram	4
3.1.2 Cautions on installation	5
3.2 Piping	5
(1) Piping method	5
(2) Piping diagram	6
(3) Conditions of sample gas	7
(4) Flow rate of sample gas	7
(5) Preparation of standard gases	7
(6) Purging inside the instrument	7
3.3 Wiring	8
(1) Wiring method	8
(2) Power terminal	8
4. OPERATION	9
4.1 Operating procedure	9
4.2 Preparations for operation	9
(1) Installation	9
(2) Purging inside the instrument	10
(3) Turning on the power	10
(4) Warm-up	10
(5) Zero calibration	10
(6) Span calibration	10
4.3 Start of measurement	10
4.4 Stop	10
5. CALIBRATION	11
5.1 Zero calibration and span calibration	11
(1) Zero calibration	11
(2) Span calibration	11



6. CHECK AND MAINTENANCE	12
6.1 Check	12
6.1.1 Check of sample gas flow rate	12
6.2 Maintenance	12
6.2.1 Spare parts	12
6.2.2 Replacement of fuse	13
6.2.3 Replacement of filter	13
6.2.4 Coarse zero/span adjustment	14
(1) Coarse zero adjustment	14
(2) Coarse span adjustment	14
7. TROUBLESHOOTING	15
8. SPECIFICATIONS	17

CAUTION ON SAFETY

First of all, read this “Caution on safety” carefully, and then use the analyzer in the correct way.

- The cautionary descriptions listed here contain important information about safety, so they should always be observed. Those safety precautions are ranked in 2 levels; DANGER and CAUTION.

 DANGER	Wrong handling may cause a dangerous situation, in which there is a risk of death or heavy injury.
 CAUTION	Wrong handling may invite a dangerous situation, in which there is a possibility of medium-level trouble or slight injury or only physical damage is predictable.

Caution on installation and transport of gas analyzer	
 DANGER	
<ul style="list-style-type: none">• This unit is not explosion-proof type. Do not use it in a place with explosive gases to prevent explosion, fire or other serious accidents.	
 CAUTION	
<ul style="list-style-type: none">• This unit should be installed in a place which conforms to the conditions noted in the instruction manual. Otherwise, it may cause electric shocks, fire or malfunction of the unit.• During installation work, care should be taken to keep the unit free from entry of cable chips or other foreign objects. Otherwise, it may cause fire, trouble or malfunction of the unit.• For lifting the gas analyzer, be sure to wear protective gloves. Bare hands may invite an injury.• Before transport, fix the casing so that it will not open. Otherwise, the casing may be separated and fall to cause an injury.	

Caution on piping



- **In piping, the following precautions should be observed. Wrong piping may cause gas leakage. If the leaking gas contains a toxic component, there is a risk of serious accident being induced. Also, if combustible gas is contained, there is a danger of explosion, fire or the like occurring.**
- Connect pipes correctly referring to the instruction manual.
- Exhaust should be led outdoors so that it will not remain in the locker and installation room.
- Exhaust from the analyzer should be relieved in the atmospheric air in order that an unnecessary pressure will not be applied to the analyzer. Otherwise, any pipe in the analyzer may be disconnected to cause gas leakage.
- For piping, use a pipe and a pressure reducing valve to which oil and grease are not adhering. If such a material is adhering, a fire or the like accident may be caused.

Caution on wiring



- The unit must be earthed as specified. Otherwise, it may cause electric shocks, malfunction, etc.
- Be sure to use a power supply of correct rating. Connection of power supply of incorrect rating may cause fire.
- Wiring work must be performed with the main power set to OFF to prevent electric shocks.
- Wires should be the proper one meeting the ratings of this instrument. If using a wire which cannot endure the ratings, a fire may occur.

Caution on use



- When handling the standard gas such as calibration gas, read the instruction manual of the standard gas carefully and use the gas correctly.



- Do not operate the instrument continuously with the door kept open. Otherwise injury may result..
- During operation, avoid opening the casing and touching the internal parts. Otherwise, you may suffer a burn or shock hazard.

Caution on maintenance and check

DANGER

- Before working with the casing open, be sure to turn off power supply, and perform air and N₂ gas purging of not only the analyzer inside, but also the sample gas line and reference gas line. In addition, carefully prevent oil and grease from adhering to the restrictor, filter, packing, etc. Otherwise, poisoning, fire or explosion may be caused due to gas leakage, etc.

CAUTION

- Before working, take off a wrist watch, finger ring or the like metallic accessories. And never touch the instrument with a wet hand. Otherwise, you will have a shock hazard.
- If the fuse is blown, eliminate the cause, and then replace it with the one of the same capacity and type as before. Otherwise, shock hazard or fault may be caused.

Others

CAUTION

- If the cause of any fault cannot be determined despite reference to the instruction manual, be sure to contact your dealer or Fuji Electric's technician in charge of adjustment. If the instrument is disassembled carelessly, you may have a shock hazard or injury.
- Do not use a replacement part other than specified by the instrument maker. Otherwise, adequate performance will not be provided. Besides, an accident or fault may be caused.
- Replacement parts such as a maintenance part should be disposed of as incombustibles, or in accordance with the local waste-disposal requirements.

1. GENERAL AND PRINCIPLE OF OPERATION

1.1 General

The magnetic force type (dumbbell type) oxygen analyzer is an instrument utilizing the magnetic property of oxygen. By detecting the deviation of the dumbbell generated by the difference of magnetization of oxygen in the dumbbell and the sample gas, oxygen can be measured quantitatively with linear output. Since the magnetic susceptibility of oxygen is larger than that of other gases, almost no gases interfere with oxygen. As distinct from pressure detection type analyzers, no standard gas is required.

1.2 Principle of measurement

All gases have positive or negative magnetic susceptibilities as shown in Table 1-1.

Among these gases, O₂, NO and NO₂ have high positive magnetic susceptibilities and are attracted strongly by magnetic field, whereas the others are diamagnetic substances. NO and NO₂ may be contained in combustion gas at negligibly low concentrations.

It is therefore possible to measure O₂ contents in various types of gases by utilizing its magnetic susceptibility. Fig. 1-1 illustrates the principle to detect O₂ contained in a gas.

Table 1-1 Relative magnetic susceptibilities of various gases

Kind of gas	Relative magnetic susceptibility	Kind of gas	Relative magnetic susceptibility
Oxygen	+100	Nitrogen	-0.42
Air	+21 (dry air)	Chlorine	-0.13
Carbon dioxide	-0.61	Hydrogen	-0.12
Argon	-0.58	Acetylene	-0.38
Ammonia	-0.58	Nitrous oxide	-0.58
Ethane	-0.83	Nitrogen monoxide	+43.8
Methane	-0.37	Nitrogen dioxide	+28.0

Fig. 1-1 illustrates the principle of operation.

In the cell, two glass spheres filled with nitrogen gas are suspended with strong metal wire. At first, the spheres are kept in balance in an inhomogeneous magnetic field. When oxygen molecules having a large magnetic susceptibility flow there, the molecules are pulled toward the stronger magnetic field zone and the spheres are moved away from the zone. The resulting deviation of the spheres is detected with the light source, reflecting mirror and light receiving element, and a current is flowed through the feedback loop to control so that the spheres can return to the initial balanced state. The current flowing through the feedback loop is proportional to oxygen concentration. Thus, oxygen concentration is converted into an electric signal.

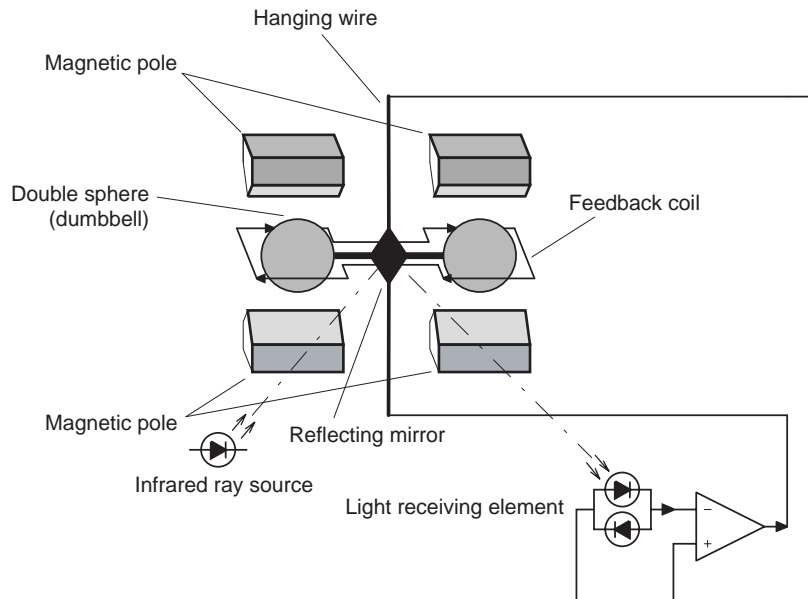
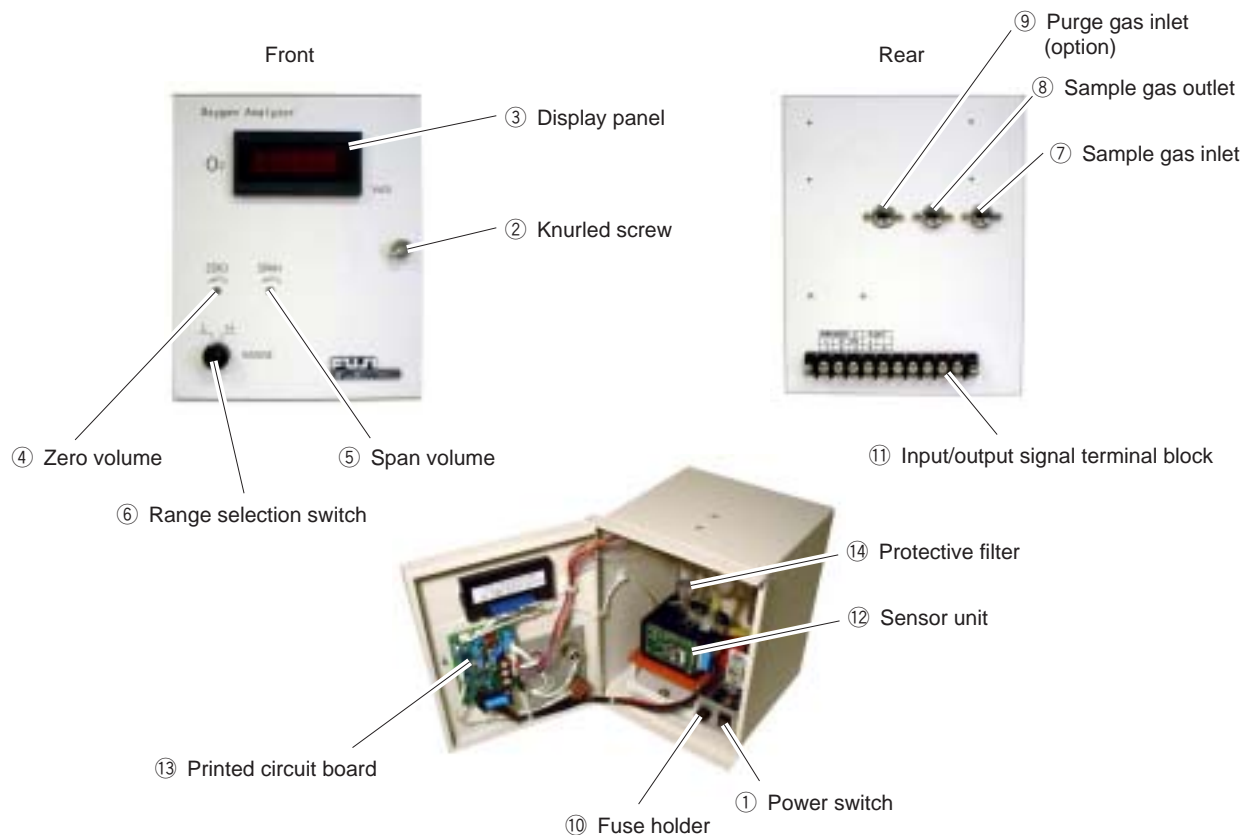

Fig. 1-1 Conceptual diagram of detector

2. NAME AND EXPLANATION OF EACH PART

2.1 Name and explanation of each part



Name	Description
① Power switch	Turned on to activate all the internal circuits.
② Knurled screw	Fastens the main frame and the casing. Loosens when turned counterclockwise.
③ Display panel	Displays gas concentration.
④ Zero volume	Volume for zero calibration
⑤ Span volume	Volume for span calibration
⑥ Range selection switch	Used for Hi-Low range switching.
⑦ Sample gas inlet	Port for connecting the sample gas injection pipe. Refer to "3.2."
⑧ Sample gas outlet	Port for connecting the pipe for discharging the gas after analysis. Refer to "3.2."
⑨ Purge gas inlet	Port for connecting the purge gas pipe. Refer to "3.2."
⑩ Fuse holder	Power fuse. Refer to "6.2.2."
⑪ Input/output signal terminal block	Terminal block for power terminal and analog output.
⑫ Sensor unit	Sensor unit for detecting oxygen
⑬ Printed circuit board	Printed circuit board for signal processing
⑭ Protective filter	Filter for sensor protection

3. INSTALLATION

⚠ CAUTION

- This analyzer weighs about 5 kg. Install it safely and securely to prevent falling.
- Before installation, make sure the knurled screw at the front face of analyzer is fixed securely. (If the knurled screw is loose, there is a risk of the internal block springing out toward you.)

3.1 Mounting

3.1.1 Outline diagram

(Unit : mm)

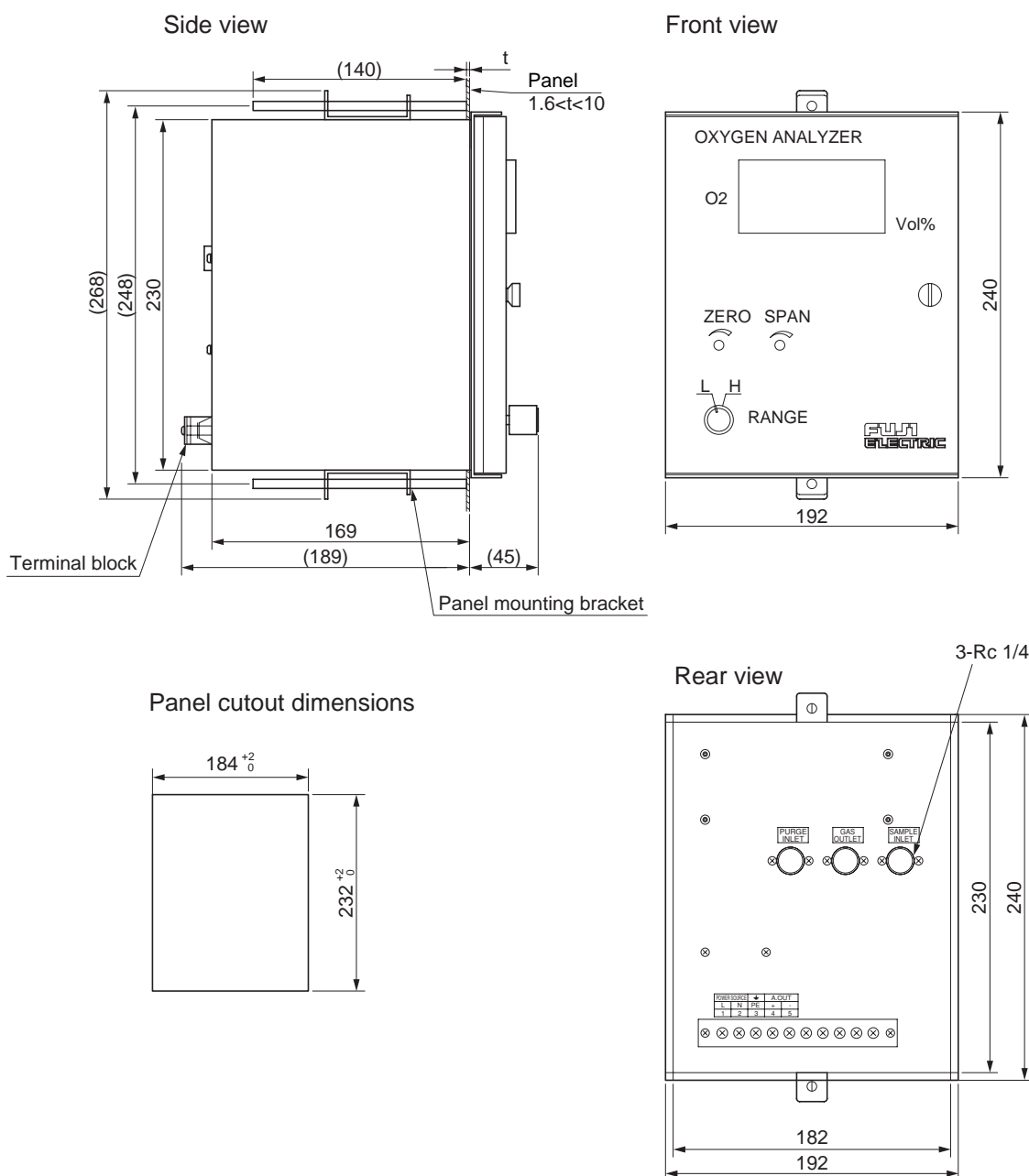

3.1.2 Cautions on installation

- (1) Mount the instrument in an upright position.
- (2) Use the panel mounting bracket supplied with the analyzer to mount it to the panel. (Refer to the outline drawing on the previous page.)
- (3) When there is a possibility of pump vibration etc., take sufficient measures to prevent vibration from being transmitted to the instrument.
- (4) Mount the instrument in a place that is not subject to direct sunlight or radiation heat from high-temperature objects.
- (5) When the instrument is to be installed outdoors, protect it from weather with an appropriate case/cover.
- (6) Select a place of clear atmosphere. Avoid a place where a corrosive or combustible gas exists.

3.2 Piping

! DANGER

- Use a pipe with no oil or grease stuck to the inside.
- Pipe joint should be tightened securely not to cause gas leakage.
- Exhaust should be discharged at a safe outdoor location so that it will not remain inside the locker and installation room.
- Exhaust from the analyzer should be relieved in the atmospheric air in order that an unnecessary pressure will not be applied to the analyzer. (Otherwise, a pipe in the analyzer may be disconnected to cause gas leakage.)

(1) Piping method

Gas pipes should be connected as shown in Fig. 3-1.

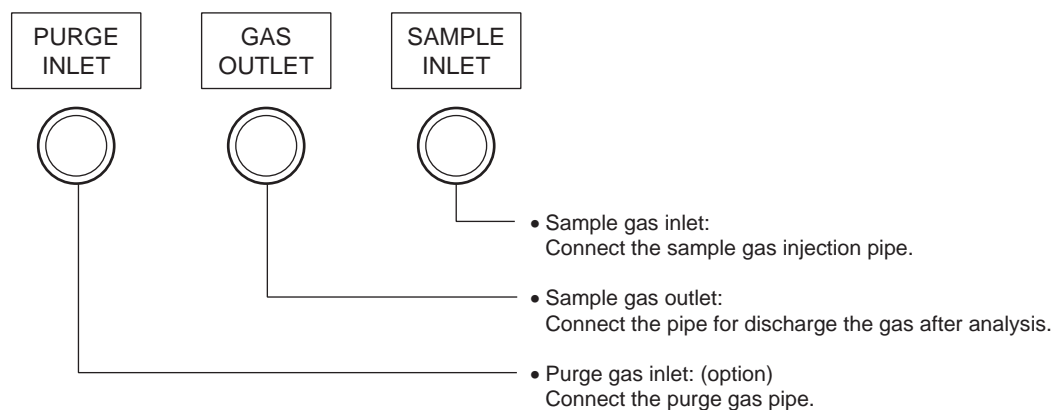

Fig.3-1 Rear face of ZKG

The end of the exhaust line should be open to the atmosphere.

PVC piping may allow oxygen to be transmitted, and as a result a display error may be caused.

Since the sample gas line has a part the temperature of which becomes the same as the ambient temperature (inlet, outlet, etc.), the dew point of the sample gas must be kept lower than the ambient temperature. If the dew point of the sample gas is high, feed the sample gas to a dehumidifier first and then to the analyzer.

It is a matter of course that the gas containing dust should be filtered, but even if it seems to be clean, provide a filter to remove dust before feeding the sample gas to the analyzer.

Note: Be sure to provide a filter of 0.3 μ m or finer before feeding gas to the analyzer. (The internal filter of the analyzer is provided for the protection of the sensor, and not for gas clarification.)

Note: Before connecting pipes to the instrument main frame, be sure to purge them to remove dust (such as iron powder) contained in them. Otherwise, iron powder etc. may come into the cell, and in the worst case, an instrument error may result.

To use this instrument incorporated into an existing gas sampling system, be sure to replace the contaminated pipes subsequent to the filter with new ones. Otherwise, dust may come in, and an instrument error may result.

Pay attention not to allow corrosive gases to be contained in the sample gas.

If a combustible gas is contained in the sample gas, be sure to purge the analyzer with a protective gas (such as N₂ or air for instrumentation) against combustible gases at the flow rate of 1.0L/min.

(2) Piping diagram

Fig. 3-2 shows sampling system diagram for ZKG measurement.

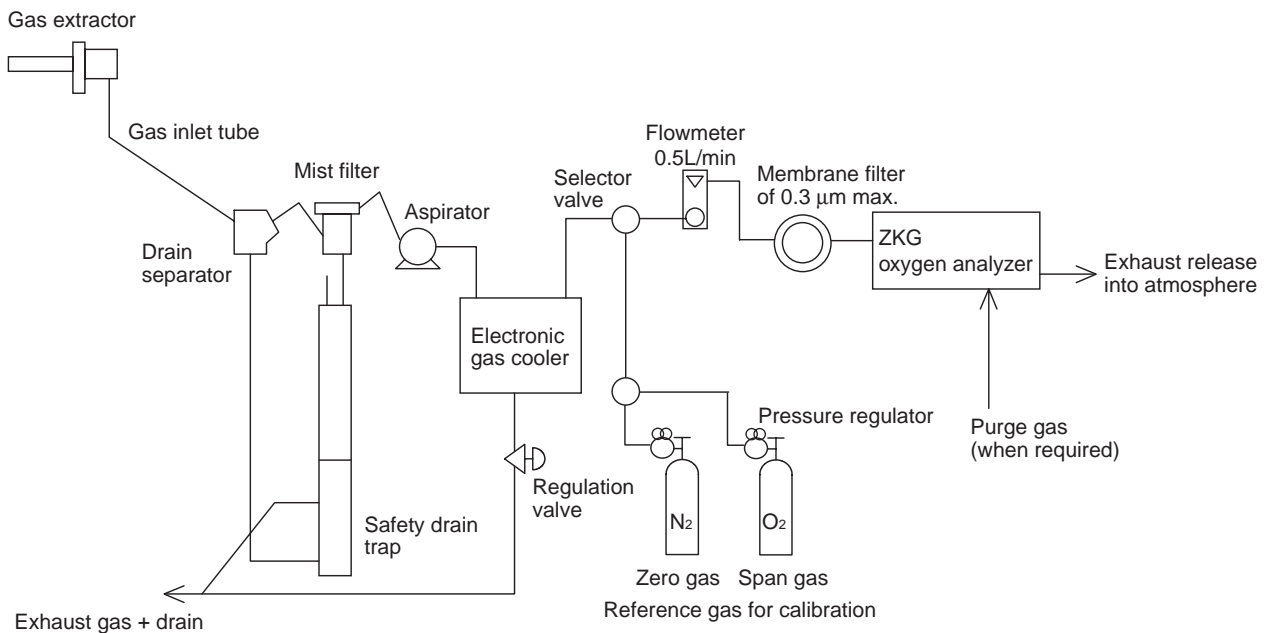

Fig. 3-2 Sampling system diagram

(3) Conditions of sample gas

- (1) The dust contained in sample gas should be eliminated completely with filters. The filter at the final stage should be capable of eliminating dust of 0.3 μ m.
- (2) The dew point of sample gas must be lower than the ambient temperature for preventing formation of drain in the analyzer. If water vapor is contained in sample gas, its dew point should be reduced down to about 0°C through a dehumidifier.
- (3) If SO₃ mist is contained in sample gas, the mist should be eliminated with a mist filter, cooler, etc. Eliminate other mist in the same way.
- (4) A corrosive gas should not be contained in the sample gas.
- (5) Sample gas temperature is allowed within a range from 0 to 50°C. Pay attention not to flow hot gas directly into the analyzer.

Note:

- Do not use the analyzer with the internal protective filter or the restrictor removed. Otherwise, a failure may result, and in the worst case, the sensor section may be damaged.
- Be careful not to feed the gas of the amount larger than the specified value to the analyzer. Sudden gas flow of the amount larger than the specified value may damage the sensor section

(4) Flow rate of sample gas

Provide a flowmeter as shown in Fig. 3-2 “Sampling system diagram” on the previous page and measure the flow rate of sample gas.

Gas flow rate
0.5L \pm 0.2L/min.

(5) Preparation of standard gases

Prepare standard gases for zero and span calibrations.

Zero gas	N ₂ gas
Span gas	O ₂ gas corresponding to 90% or more of full scale in each range + N ₂ balance gas

(6) Purging inside the instrument

The inside of instrument need not be purged generally except for the following cases.

- (1) A combustible gas component is contained in sample gas.
- (2) Corrosive gas is contained in the atmospheric air at the installation site.
- (3) The same gas as the sample gas component is contained in the atmospheric air at the installation site.

In such cases as above, the inside of analyzer should be purged with the air for instrumentation or N₂.

Purging flow rate should be about 1L/min.

If dust or mist is contained in purging gas, it should be eliminated completely in advance.

3.3 Wiring

CAUTION



Wiring work is allowed only when all power supplies are turned off. Otherwise, shock hazard will be caused.)



Be sure to ground the analyzer.

(1) Wiring method

Each external terminal is provided on the rear face of the analyzer. (See Fig. 3-3.)

Wire each terminal, referring to Fig. 3-3

- Note:**
- For connection of output signal, use a shielded wire in order to suppress the influence by external noise.
 - To assure safety, be sure to cover the wiring with terminal block protective cover after wiring is completed.

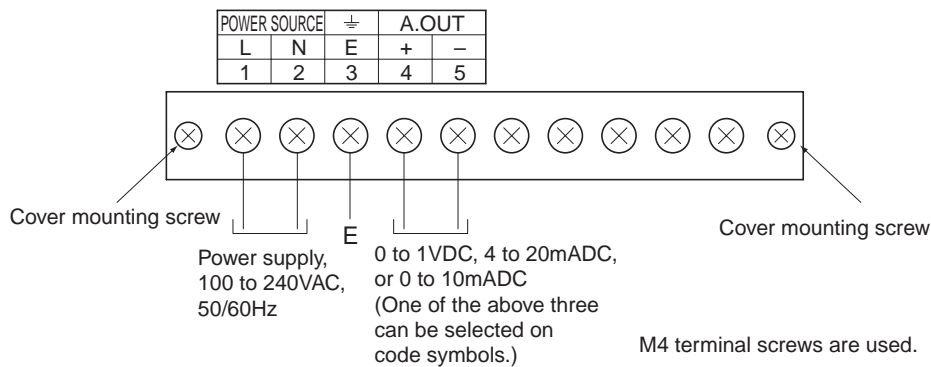

Fig. 3-3 Each position of external terminals

(2) Power terminal

Power terminals are provided as shown in Fig. 3-3.

Connect the power supply to the power supply terminal, and the grounding wire to the grounding terminal. Class D grounding should be established.

For the wire to be connected to each terminal, use a solderless terminal (for M4).

When noise source is in the vicinity

Do not install the analyzer near power noise generating electric equipment (such as high frequency furnace and electric welder). If the analyzer must be used near such equipment, a separate power line should be used for avoiding noise.

In case noise may enter from a relay, solenoid valve, etc. through power supply, connect a varistor or spark killer to the noise source as shown in the diagram. If the varistor or spark killer is located away from the noise source, no effect is obtainable. So, locate near the noise source.

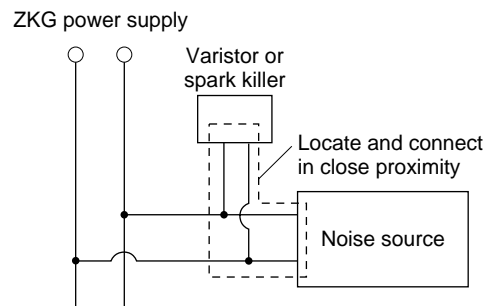

4. OPERATION

CAUTION

- Before operation, read the instruction manual carefully. After acquisition of an adequate understanding, you should start operation.

4.1 Operating procedure

Carry out operation in the procedure shown in Fig. 4-1. After confirming the operational preparations in ① to ⑤, turn on power supply for start.

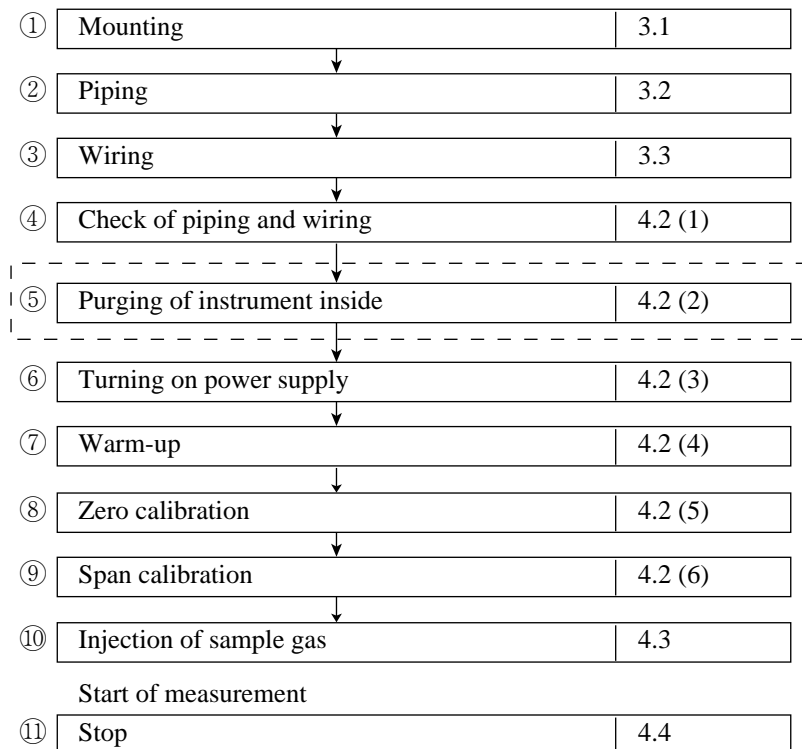

Note:

The steps enclosed by dashed line should be effected as required.

Fig. 4-1 Operating procedure

4.2 Preparations for operation

(1) Installation

Read “Mounting,” “Piping” and “Wiring” in Chapter 3 carefully before starting the installation. After the instrument is installed, check once again that the installation conditions are appropriate.

(2) Purging inside the instrument

When the instrument is installed in an environment containing a combustible or corrosive gas, or a lot of dust, purge the main frame with N₂ gas or air at the flow rate of 1.0L/min. When a combustible gas is contained, feed purge gas before turning on the power (30 minutes before in the case of N₂, or one hour before in the case of air).

(3) Turning on the power

Setting the power switch to “ON” lights up the measurement LED. The output value display becomes off-scale on the + side once, and then (approximately 2 seconds later) returns to the normal value.



Turning on the power lights up the measurement LED.

(4) Warm-up

After turning on power supply, warm up the instrument. When indication has stabilized (after 30 minutes or more), warm-up is completed.

(5) Zero calibration

Carry out zero calibration with the zero calibration gas flowed. For procedure, refer to “5.1 (1)”

(6) Span calibration

Carry out span calibration with the span calibration gas flowed. For procedure, refer to “5.1(2)”

4.3 Start of measurement

Feed the sample gas. Check that the gas is being fed at the specified flow rate (0.5L/min.)

4.4 Stop

Stop injection of the sample gas and flow dry N₂ gas through the sample gas inlet for 10 minutes to purge the inside of measuring cell. Then, stop the flow of N₂ gas. Turn off the power switch.

5. CALIBRATION

5.1 Zero calibration and span calibration

- We recommend you to perform calibration once a week or as required.
- Perform zero calibration first, and then span calibration. Performing span calibration first and then zero calibration may cause the span point to deviate.
- Perform calibration in the range of use.
- Before starting the calibration, check that the range selection switch is set to the range to be calibrated.
- Before starting the calibration, warm up the instrument fully.
- Be careful not to feed the calibration gas of the amount larger than the specified value. Sudden gas flow of the amount larger than the specified value may damage the sensor section.

(1) Zero calibration

Feed the zero gas at the specified flow rate (0.5L/min).

After the indication becomes stable enough, make an adjustment with the zero volume so that the output between output terminals 4 (+) and 5 (-) becomes 0% O₂.



(2) Span calibration

Feed the span gas at the specified flow rate (0.5L/min).

After the indication becomes stable enough, make an adjustment with the span volume so that the output between output terminals 4 (+) and 5 (-) coincides with the concentration of the standard gas.



6. CHECK AND MAINTENANCE

DANGER

- Before working with the casing open, be sure to turn off power supply, and perform air or N₂ gas purging of not only the analyzer inside, but also the sample gas line. In addition, carefully prevent oil and grease from adhering to the pipe etc. Otherwise, poisoning, fire or explosion may be caused due to gas leakage, etc.

CAUTION

- Before working, take off a wrist watch, finger ring or the like metallic accessories. And never touch the instrument with a wet hand. Otherwise, you will have a shock hazard.
- If the fuse is blown, eliminate the cause, and then replace it with the one of the same capacity and type as before. Otherwise, shock hazard or fault may be caused.

CAUTION

- If the cause of any fault cannot be determined despite reference to the instruction manual, be sure to contact your dealer or Fuji Electric's technician in charge of adjustment. If the instrument is disassembled carelessly, you may have a shock hazard or injury.
- Do not use a replacement part other than specified by the instrument maker. Otherwise, adequate performance will not be provided. Besides, an accident or fault may be caused.
- Replacement parts such as a maintenance part should be disposed of as incombustibles, or in accordance with the local waste-disposal requirements.

6.1 Check

6.1.1 Check of sample gas flow rate

Check that the sample gas is fed at the flow rate of 0.5L/min.

Check also that the calibration gas is fed at the flow rate of 0.5L/min.

6.2 Maintenance

CAUTION

Before operating the analyzer after a long shutdown, maintenance and check by an authorized technician is required.

6.2.1 Spare parts

No.	Name	Our type	Usage
1	Fuse	75726N3	For power supply
2	Filter	TK7L8925P1	For the protection of internal sensor

6.2.2 Replacement of fuse

Before replacing the fuse, make sure that the power switch is set to “OFF.”

Be sure to use the replacement fuse designated by us.

250VAC 0.5A delay type $\phi 5 \times 20$ mm glass tube fuse



Fuse holder

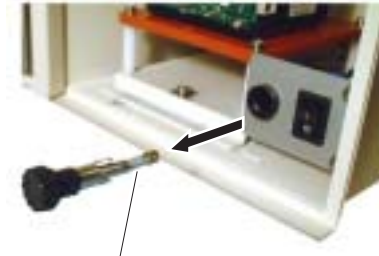

Fuse

6.2.3 Replacement of filter

Replace the filter when it is clogged (see the following photos).

* The filter inside the analyzer is provided for the protection of the sensor (and not for sample gas clarification).

If the internal filter is clogged, examine the gas clarification of the front stage of the analyzer carefully. Before replacing the filter, be sure to turn off the power and check that no gas is fed.

Hose band



- Remove the hose band and draw out the tube in the direction of the arrow.

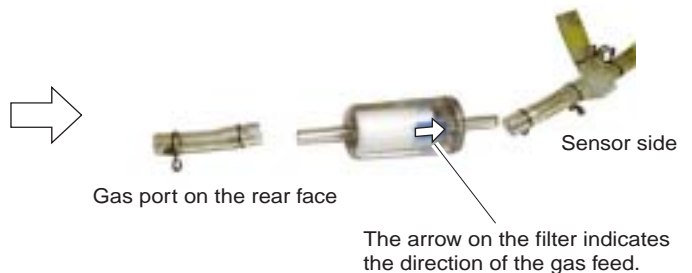

Gas port on the rear face

Sensor side

The arrow on the filter indicates the direction of the gas feed.

Pay attention to the mounting direction of the filter. (The arrow on the filter indicates the direction of the gas feed.)

6.2.4 Coarse zero/span adjustment

Before making an adjustment described in this section, be sure to check the flow rate of the calibration gas according to the troubleshooting in Chapter 7. Do not make the adjustment except when the instrument cannot be calibrated using the ZERO or SPAN volume on the front face.

(1) Coarse zero adjustment

- (1) Feed the zero gas at the specified flow rate (0.5L/min).
- (2) When there are 2 ranges, select the lower range.
- (3) Adjust the zero volume on the front face to the center.
- (4) Adjust the coarse zero adjustment volume inside the analyzer with a precision driver so that the reading indicates around 0% O₂.
- (5) Make fine adjustments with the zero volume on the front face.



(2) Coarse span adjustment

- (1) Feed the span gas at the specified flow rate (0.5L/min).
- (2) When there are 2 ranges, select the lower range.
- (3) Adjust the span volume on the front face to the center.
- (4) Adjust the coarse span adjustment volume inside the analyzer with a precision driver so that the reading indicates the value equivalent to the span gas concentration.
- (5) Make fine adjustments using the span volume on the front face.

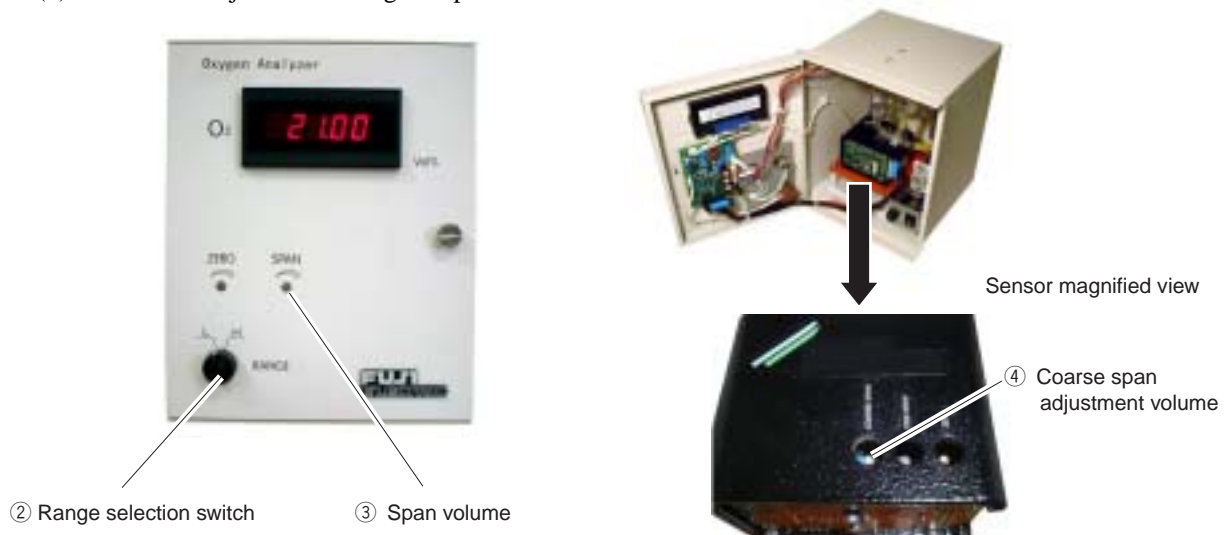

7. TROUBLESHOOTING

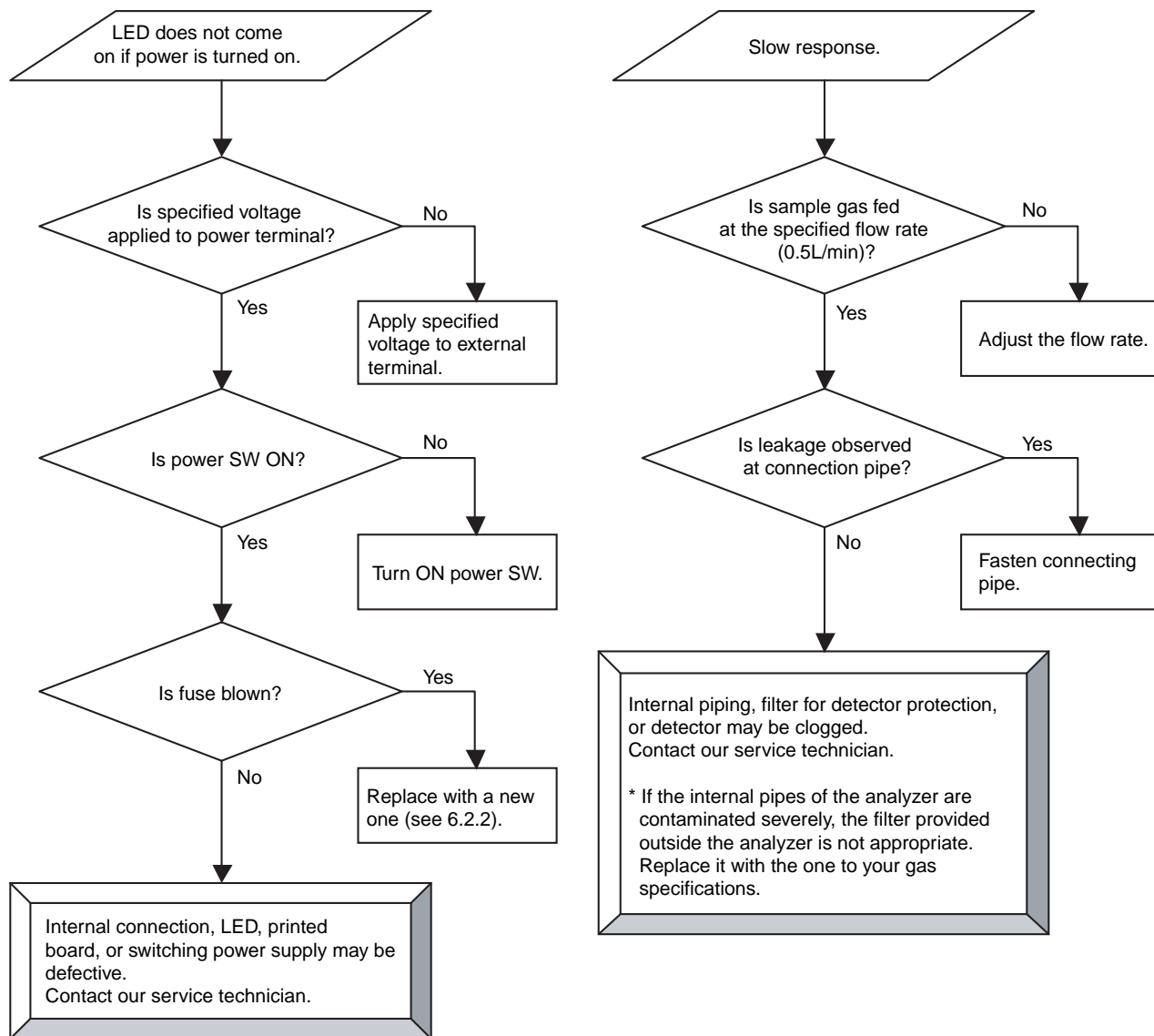

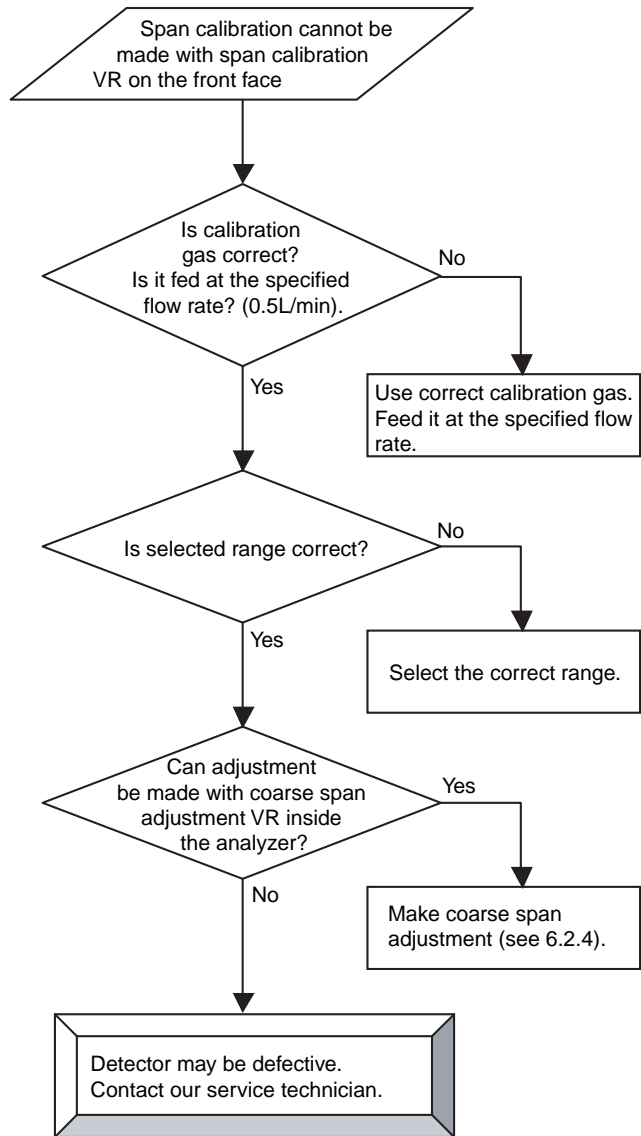
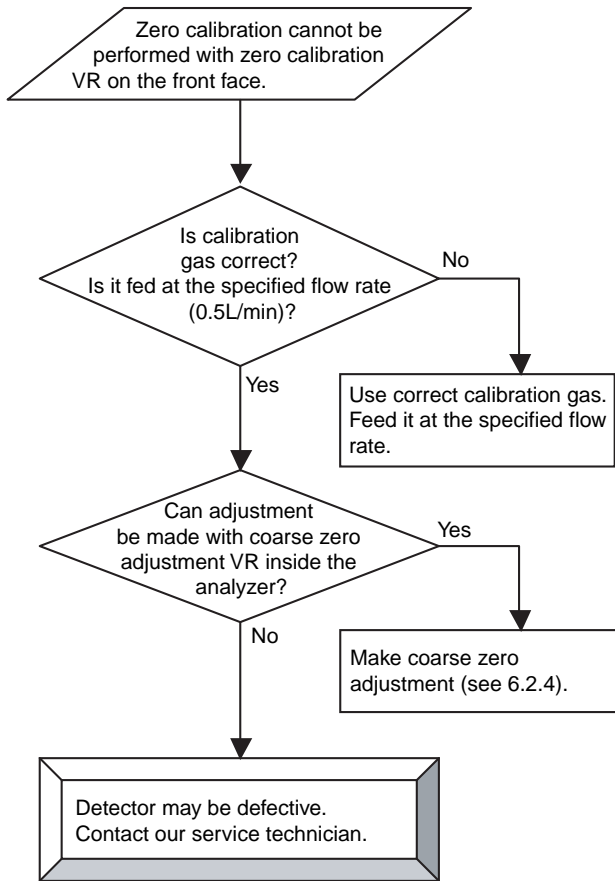

8. SPECIFICATIONS

Measuring range: 0 to 10, 25, 50, 100vol% O₂

Number of ranges: 1 or 2 ranges (selectable by code symbol)

Measuring system: Paramagnetic (dumbbell type)

Output signal: One of the following signals (selectable by code symbol)
4 to 20 mA DC (load resistance 550 Ω max)
0 to 1 V DC (permissible load resistance 100 kΩ min)
0 to 10 mV DC (permissible load resistance 100 kΩ min)

Repeatability: Within ±0.5% of full scale

Linearity: Within ±1.0% of full scale

Zero drift: Within ±2.0% of full scale/week

Span drift: Within ±2.0% of full scale/week

Response time: Within 15 sec (90% response)

Flow rate of sample gas: 0.5 L/min ± 0.2 L/min

Pressure loss: Approx. 0.3 kPa
(at sample gas flow rate 0.5 L/min)

Flow rate of purge gas (option): 1 L/min, N₂ or air
(flowed for purging corrosive ambient gas)

Power supply: 100 to 240 V AC, 50/60 Hz

Power consumption: Approx. 35 VA

Ambient temperature: 0 to 45°C

Ambient humidity: 90% RH or less

Warm-up time: Approx. 30 minutes

Materials of gas-contacting parts: SUS304, SUS316, fluororubber, borosilicate glass, Electroless Nickel, platinum, platinum/iridium alloy, Teflon, Toaron, PVDF (polyvinylidene fluoride), fluorocarbon resin glass fiber

Interference due to coexisting gas:

Interfering gas	Interfering gas concentration	Interfering concentration
NO	2000ppm	0.15vol% O ₂ max.
CO	100vol%	0.1vol%O ₂ max.
CO ₂	100vol%	- 0.35vol%O ₂ max.
CH ₄	100vol%	- 0.25vol%O ₂ max.

Enclosure: Steel casing, for indoor application, flush mounting on panel

External dimensions (H x W x D): 240 x 192 x 234 mm

Mass: Approx. 5 kg

Finish color: Munsell 2.5Y8.4/1.2

Measuring gas conditions:

Temperature: 0 to 50°C

Humidity: Dew point at least 10°C lower than ambient temperature

Dust: Max. 100 µg/N m³ in particles of max. 0.3 µm each

Mist: Unallowable

Pressure: 10 kPa or less

Installation conditions:

- The instrument must be protected from direct sunlight and heat radiation from objects at high temperature.
- For installing the instrument outdoors, it must be protected from rain and wind with a suitable casing or cover.
- The instrument must be installed in a clean atmosphere free from corrosive or combustible gas.
- The instrument must be free from severe external vibrations.

Mounting: Vertical mounting on panel

Panel cutout dimensions (mm)

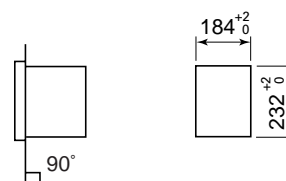

Fuji Electric Systems Co., Ltd.

Head Office

Gate City Ohsaki, East Tower, 11-2, Osaki 1-chome,
Shinagawa-ku, Tokyo 141-0032, Japan
<http://www.fesys.co.jp/eng>

Instrumentation Div.

International Sales Dept.

No.1, Fuji-machi, Hino-city, Tokyo 191-8502, Japan
Phone: 81-42-585-6201, 6202 Fax: 81-42-585-6187
<http://www.fic-net.jp/eng>
